

ST01060CH

FAA Supplemental Type Certificate



Single or Dual ARINC 743A GPS Antenna and Coaxial Cable Installation on 737 Series Aircraft (FAA STC ST01060CH)

OVERVIEW

» FAA STC ST01060CH

Contact CarlisleIT for usage rights, derivative configurations, and installation lead time (800) 327-9473 • sales@carlisleit.com

INTRODUCTION

STC ST01060CH installs single or dual GPS antenna provisions, ARINC 743A GPS antennas and coaxial cables on 737-200/-300/-400/-500 series aircraft. The location of the antenna installations are given below.

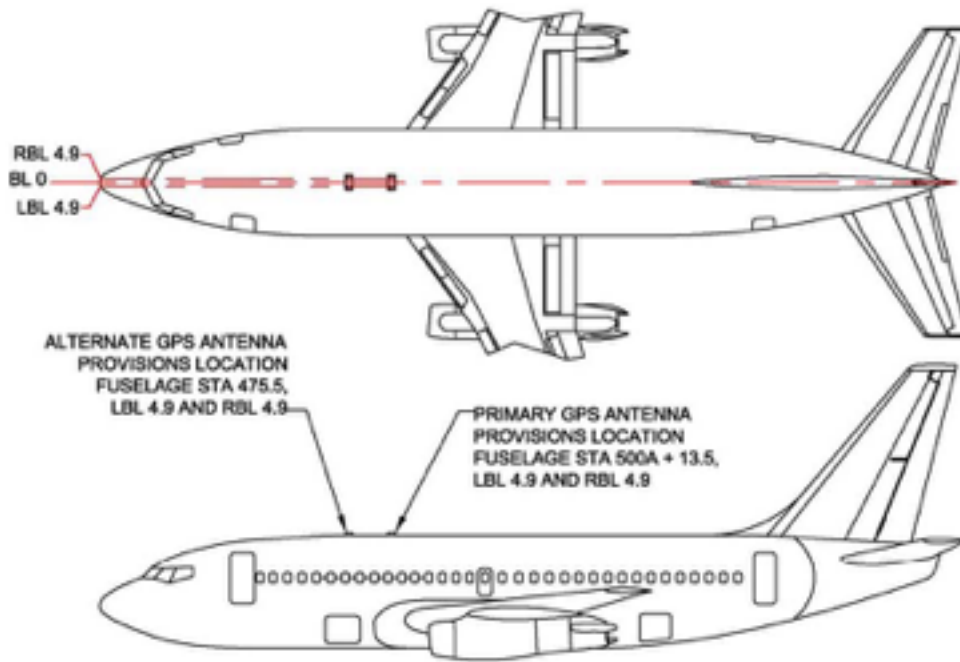

737-200 SERIES AIRCRAFT

ST01060CH

FAA Supplemental Type Certificate

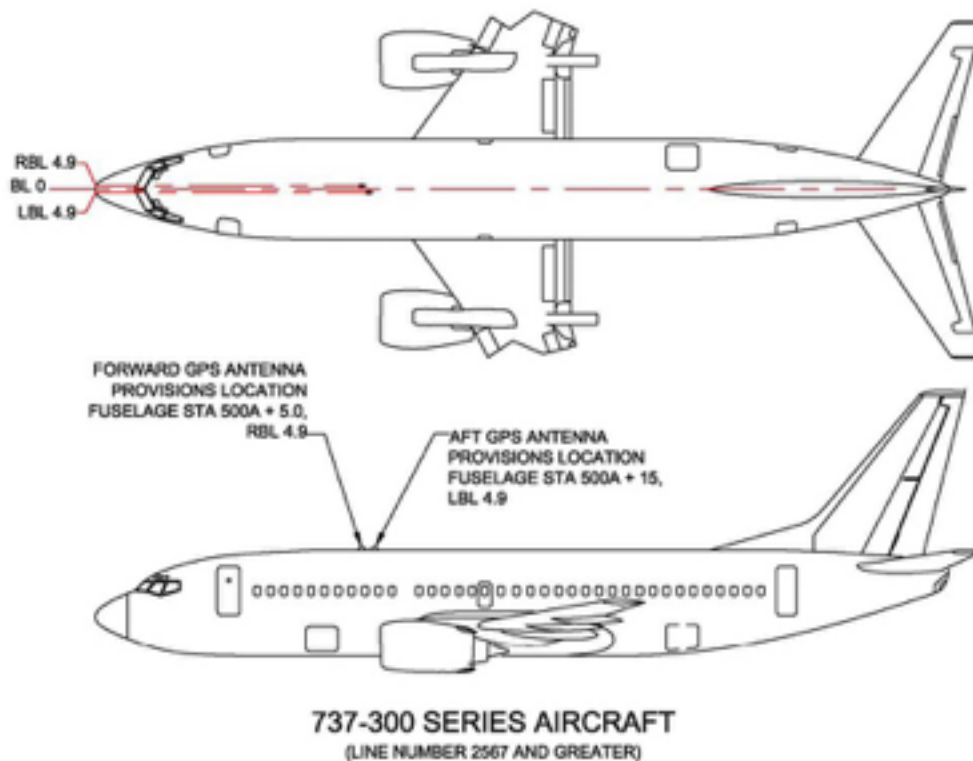
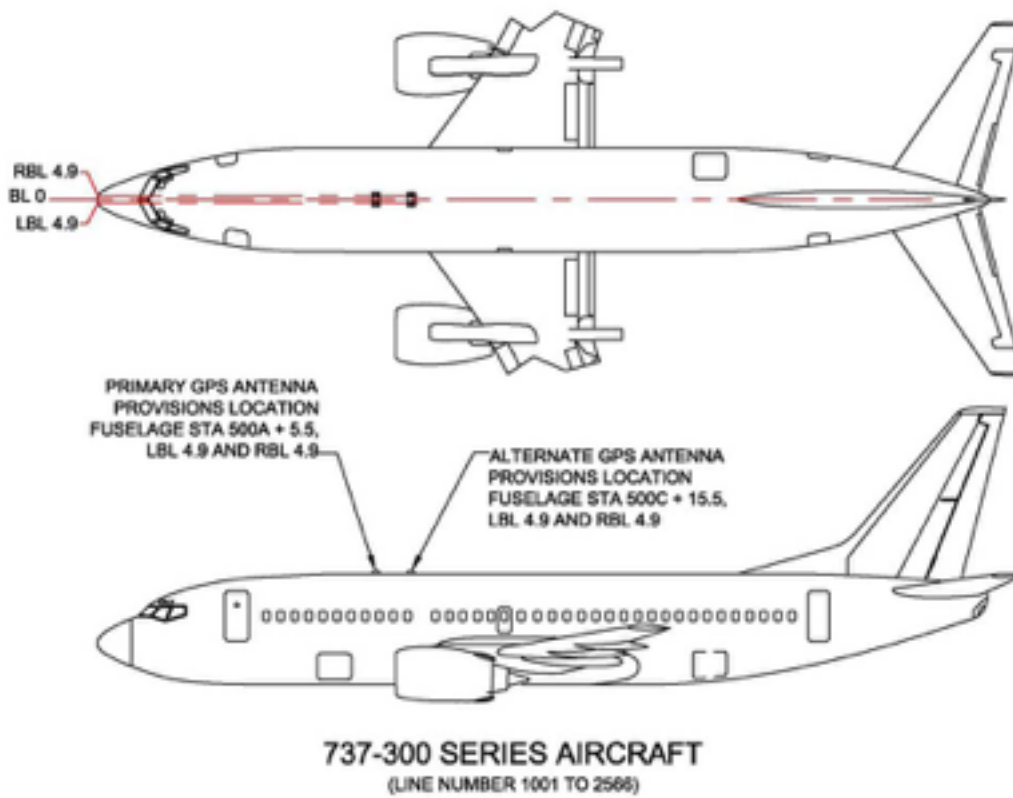

ST01060CH

FAA Supplemental Type Certificate

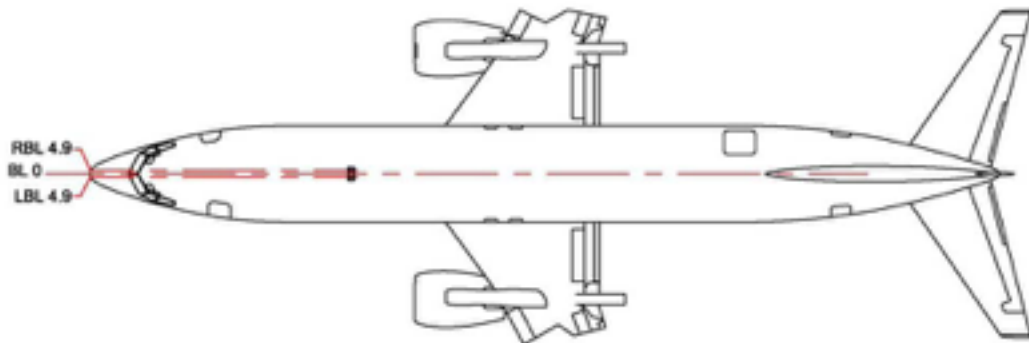

PRIMARY GPS ANTENNA
PROVISIONS LOCATION
FUSELAGE STA 500A + 6.5,
LBL 4.9 AND RBL 4.9

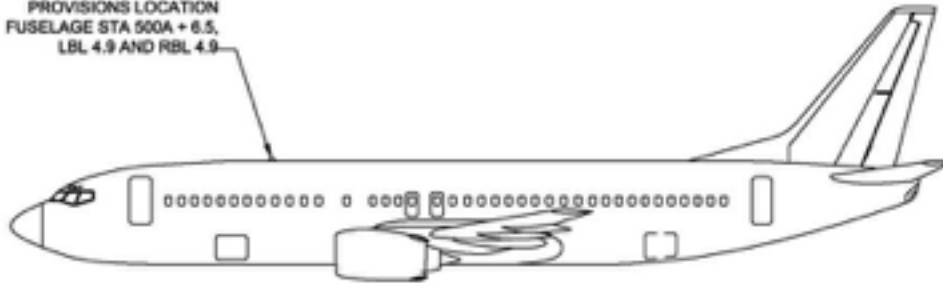

737-400 SERIES AIRCRAFT
(LINE NUMBER 1001 TO 2567)

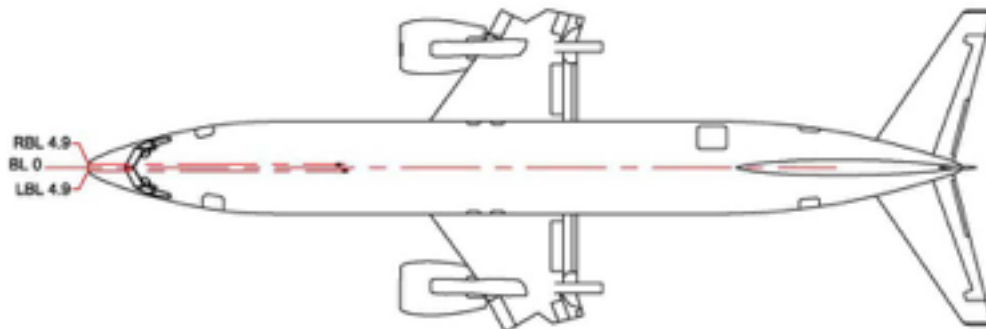

FORWARD GPS ANTENNA
PROVISIONS LOCATION
FUSELAGE STA 500A + 5.0,
RBL 4.9

AFT GPS ANTENNA
PROVISIONS LOCATION
FUSELAGE STA 500A + 15,
LBL 4.9

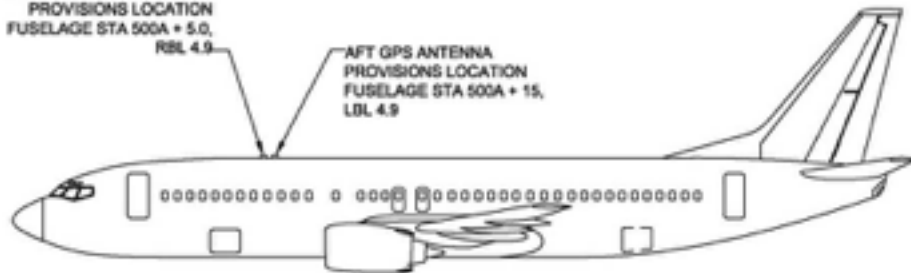

737-400 SERIES AIRCRAFT
(LINE NUMBER 2568 AND GREATER)

ST01060CH

FAA Supplemental Type Certificate

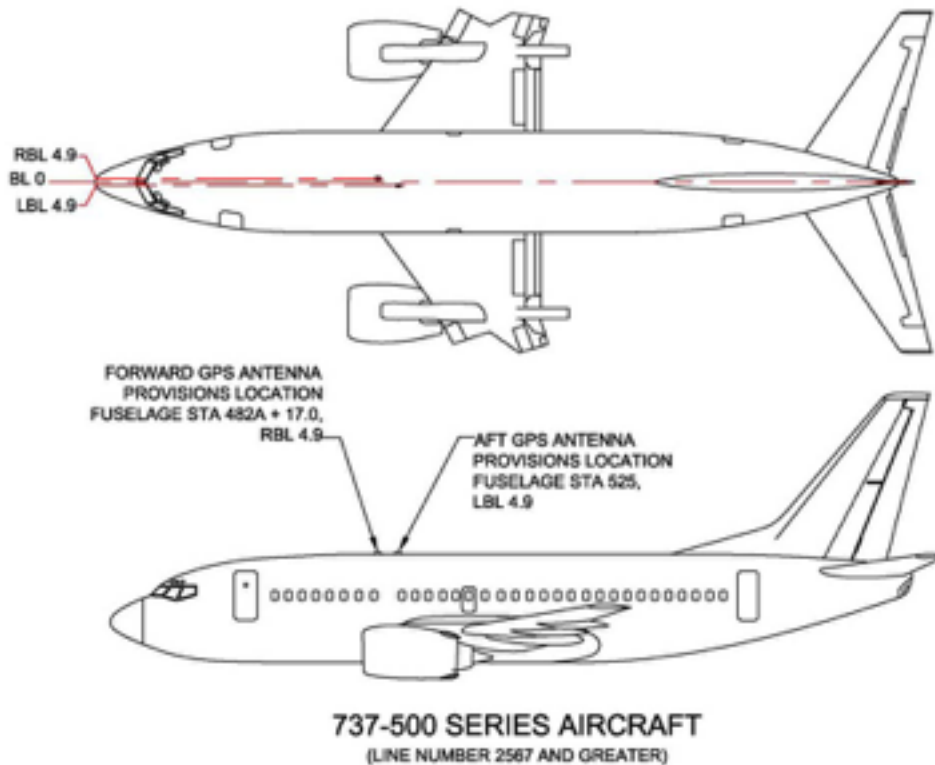
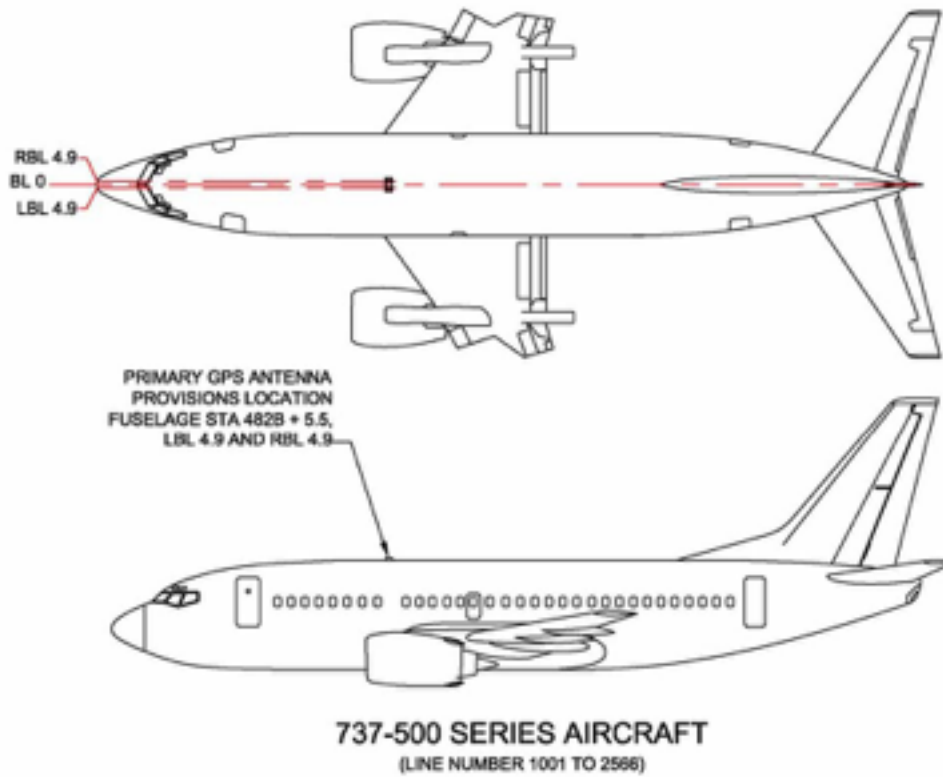

ST01060CH

FAA Supplemental Type Certificate

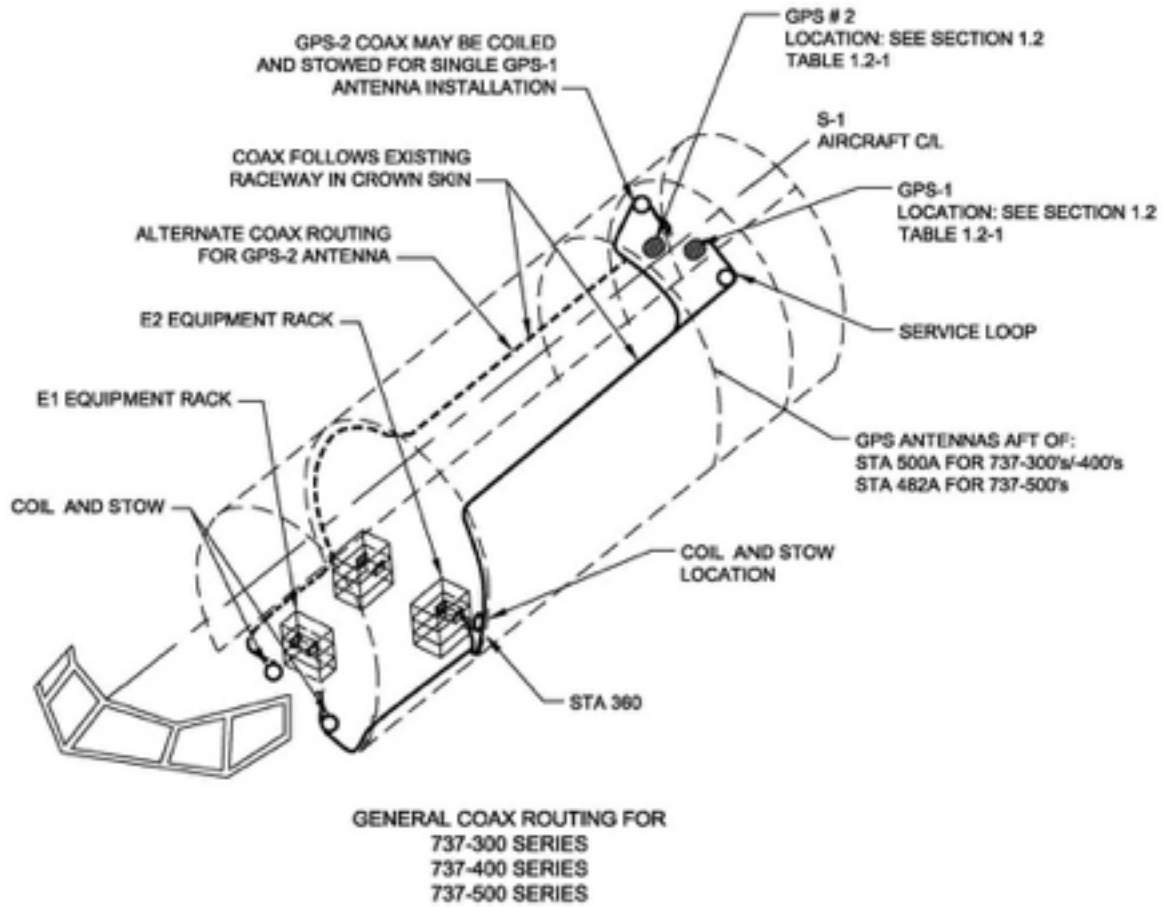

ST01060CH

FAA Supplemental Type Certificate

YOUR NEEDS

This STC can be used to support any modification or existing system that requires an independent position source. This STC supports the installation of an ARINC 743A GPS antenna. Any ARINC 743A GPS antenna not supported by the STC can be added via a minor change to the STC.

YOUR BENEFITS

Carlisle Interconnect Technologies (CarlisleIT) offers a turnkey solution to the installation of a GPS antenna. We provide all engineering and maintenance data required by the STC. Additionally, CarlisleIT can provide an installation kit providing all the materials necessary for the installation.

APPROVALS

- » FAA STC: ST01060CH
- » UKRAINE STC:
- » BRAZIL STC: 2010S02-06
- » FRENCH STC: IM135-SI-0667
- » ARGENTINA STC: CTS 0604.18(A)
- » SPAIN STC: S344-I

ENVIRONMENTAL APPROVALS

Antennas to be installed need to have TSO or PMA approval. CarlisleIT can provide a list of current eligible antennas.

FLAMMABILITY

The coaxial cables are approved for flammability per 14 CFR 25.869(a)(4) Amdt 25-113 and Appendix F Part 1 (a)(3).

OPERATION

N/A

INSTALLATION

Installation time is approximately 8 Mhrs for the antenna provisions and 16 Mhrs for the coaxial cable installation. CarlisleIT can provide a turnkey installation kit providing all the materials required for the installation.

DURABILITY

All installed components do not require any regular maintenance. The STC modifies Fatigue Critical Baseline Structure (FCBS). Inspections intervals and procedures are provided in the Instructions for Continued Airworthiness (ICA). Inspection intervals are generally on the order of 10,000 cycles and are primarily dependent on the 737 model being modified.

CLEANING

No special cleaning requirements.

POWER

No power required.

ST01060CH

FAA Supplemental Type Certificate

LAYOUT & DIMENSIONS

For each applicable aircraft series (737-300, 737-400, 737-500), there are two installation configurations based on aircraft line number. For the earlier series aircraft, the provisions installation includes an external doubler that spans stringers S-2L, S-1, S-2R, and provides provisions for mounting two side-by-side GPS antennas. A view of the installation is shown below.

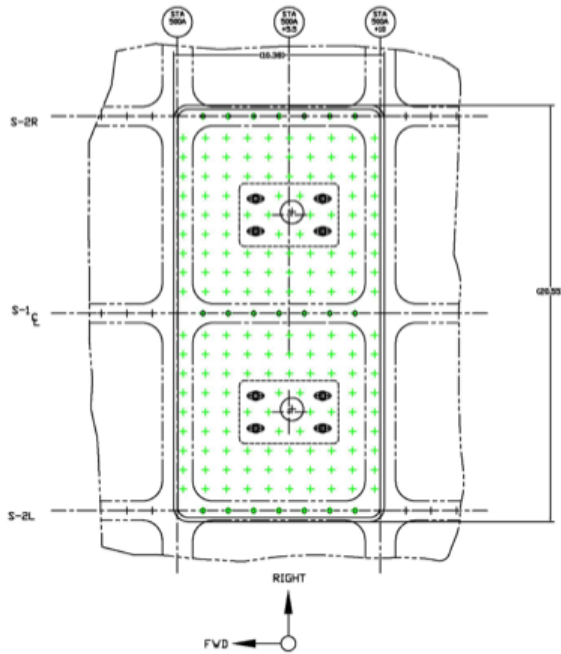

737-300 Shown, Other 737 Series are similar

For later series aircraft, Boeing has provided a skin “pad-up” area to install the antenna. The typical structural provisions installation for these aircraft includes an internal antenna retainer and is shown below.

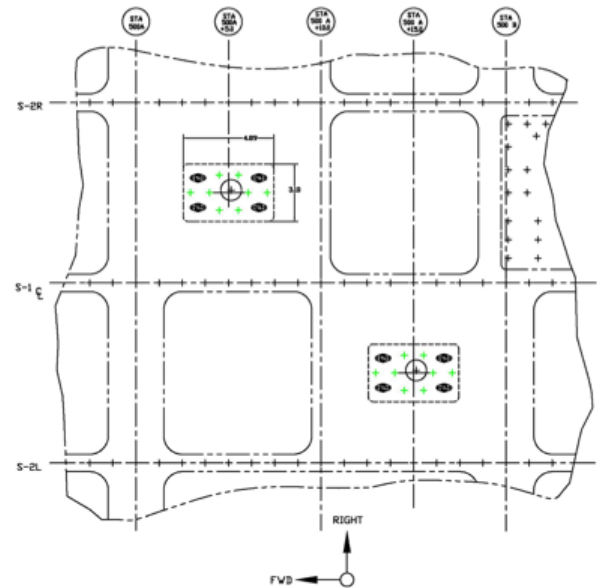

737-300 Shown, Other 737 Series are similar

YOUR BENEFITS

ST01060CH has been installed for the past 15 Years on more than 500 aircraft with no reported problems.

CONNECT WITH US TODAY

See CarlisleIT's line of **Certification Services** at:
CarlisleIT.com/services/certification-stc-engineering

(+1) 904-494-0549
Sales@CarlisleIT.com