

4

3

DWG NO. CTRE3522-1 SH 1 REV. C

1

This print and associated documents and the contained information are the confidential property of ELECTRONIC CABLE SPECIALISTS. Disclosure of, and/or reproduction of, all or part thereof or manufacture of any part from information contained on this print not specifically permitted by ELECTRONIC CABLE SPECIALISTS in writing is forbidden.

INSTALLATION INSTRUCTIONS

1. BEGIN BY CUTTING THE CABLE OFF SQUARE.

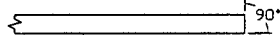

2. STRIP THE CABLE AS SHOWN, BEGINNING WITH L1 AND ENDING WITH L2. TAKE CARE NOT TO NICK THE CONDUCTORS WHILE STRIPPING THE DIELECTRIC AND JACKET. THE USE OF A STRIPPER DESIGNED FOR COAXIAL CABLE IS RECOMMENDED.



3. SLIDE THE FERRULE AND ADHESIVE SHRINK TUBING OVER THE END OF THE CABLE.



4. USING TWEEZERS, FOLD THE OUTER BRAID BACK OVER THE CABLE JACKET, LEAVING AS MUCH WEAVE AS POSSIBLE.



5. USING TWEEZERS, FOLD THE INNER BRAID BACK OVER THE OTHER SHIELD, LEAVING AS MUCH WEAVE AS POSSIBLE.

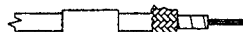

6. REMOVE THE DIELECTRIC FROM THE CENTER CONDUCTOR BACK TO THE BEGINNING OF THE FOLDED BACK SHIELD, APPROXIMATELY .60 INCHES FROM THE END OF THE CENTER CONDUCTOR. BE CAREFUL NOT TO NICK THE CENTER CONDUCTOR. THERMAL STRIPPERS ARE RECOMMENDED.



7. INSTALL DIELECTRIC STIFFENER OVER CENTER CONDUCTOR, ENSURING THAT IT IS BUTTED AGAINST THE CABLE DIELECTRIC.



8. SOLDER THE CENTER CONTACT ONTO THE CENTER CONDUCTOR PER MIL-STD-2000, USING 63Sn/37Pb SOLDER OR CRIMP WITH A M22520/5-11 DIE (B HEX). ENSURE THE CONTACT IS BUTTED AGAINST THE CABLE DIELECTRIC STIFFENER. CLEAN ALL FLUX RESIDUES USING APPROPRIATE FLUX CLEANER.

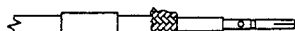

REVISIONS					
ECN	ZONE	REV.	DESCRIPTION	DATE	APPROVED
5884		N/C	NEW RELEASE.	8/26/97	MCT
6189	A		ADDED INNER DIMENSIONS FOR CONN.	9/10/98	MCT
12904	B		SEE ECN	12/19/00	CAC
13466	C		SEE ECN	7/24/01	C. Chapman

8. SLIDE THE BODY OF THE CONNECTOR OVER THE END OF THE CABLE UNTIL THE NOTCH IN THE CONTACT SEATS WITH THE DIELECTRIC RIDGE INSIDE THE CONNECTOR. CAUTION: PUSH CABLE INTO CONNECTOR STRAIGHT TO AVOID KINKING.

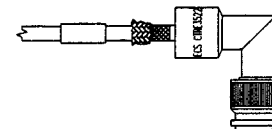

9. FOLD BOTH BRAIDS UP OVER THE NECK OF THE CONNECTOR BODY.

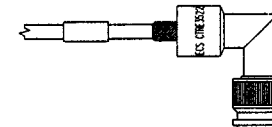

10. SLIDE THE FERRULE UP OVER THE SHIELDS AND AGAINST THE CONNECTOR BODY. TRIM AWAY ANY EXCESS BRAID. CRIMP THE FERRULE ONCE, NEXT TO THE BODY, USING A M22520/5-11 DIE, (A HEX), IN A M22520/5-01 TOOL FRAME. APPLY ADHESIVE HEAT SHRINK.

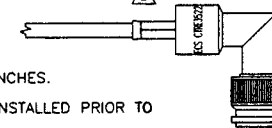

NOTES

- ALL DIMENSIONS ARE IN INCHES.
- ENSURE HEAT SHRINK IS INSTALLED PRIOR TO CRIMPING CONNECTOR.
- ADHESIVE HEAT SHRINK SHOULD BE APPLIED IN ACCORDANCE WITH ECS WORK INSTRUCTION W10007. CONTACT ECS FOR A COPY OF THIS WORK INSTRUCTION.
- CONNECTOR DIMENSIONS ARE FOR REFERENCE ONLY.
- DELETED-
- DELETED-

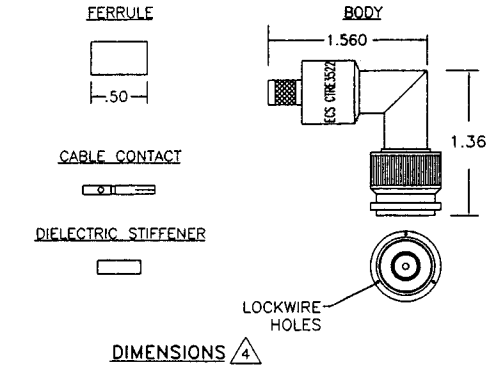

SPECIFICATIONS

ELECTRICAL

IMPEDANCE: 50 OHMS NOMINAL
 FREQUENCY RANGE: 0-11GHz
 VSWR: 1.2:1 MAXIMUM DC TO 2GHz
 INSERTION LOSS: .1dB MAXIMUM DC TO 2GHz
 WORKING VOLTAGE: 500 VRMS @ SEA LEVEL
 DIELECTRIC WITHSTANDING: 1500 VRMS @ SEA LEVEL
 INSULATION RESISTANCE: 5000 MEGOHMS MINIMUM @ 500 VOLTS DC

MECHANICAL

CONNECTOR INTERFACE: DIMENSIONS PER MIL-STD-348A FIGURE 313-1
 TERMINATION STYLE: CABLE CONTACT-SOLDER OR CRIMP FERRULE-CRIMP
 CABLE RETENTION: 20 LBS

ENVIRONMENTAL

TEMPERATURE RATING: -65° TO +165° C
 VIBRATION: MIL-STD-202, METHOD 204, COND. B
 SHOCK: MIL-STD-202, METHOD 213, COND. I
 THERMAL SHOCK: MIL-STD-202, METHOD 107, COND. B
 CORROSION: MIL-STD-202, METHOD 101, COND. B
 MOISTURE RESISTANCE: MIL-STD-202, METHOD 106

MATERIALS

BODY: BRASS PER QQ-B-626
 FERRULE: ANNEALED BRASS PER QQ-B-626
 CABLE CONTACT: BERYLLIUM COPPER PER QQ-C-530
 CENTER CONTACT: BRASS PER QQ-B-626
 OUTER CONTACT: BERYLLIUM COPPER PER QQ-C-530
 DIELECTRIC: TEFLON PER L-P-403
 GASKET: SILICON RUBBER PER ZZ-R-765

FINISHES

BODY, FERRULE AND OUTER CONTACT: BRIGHT NICKEL PER QQ-N-290
 CENTER CONTACT: GOLD PER MIL-G-45204

APPROVALS		DATE	ECS ELECTRONIC CABLE SPECIALISTS FRANKLIN, WI 53132 PHONE: (414) 421-5300		
DRAWN BY: M TAUBENHEIM		8/26/97	TITLE: CUSTOMER SPECIFICATION		
CHECKED BY: M TAUBENHEIM		8/26/97	90 DEG TNC EXTENDED BODY PLUG FOR ECS COAX CABLE 352001		
DESIGNED BY:			SIZE	CAGE CODE	LEVEL PART NO.
PROJECT ENG: JB HACKETT		8/26/97	B	66197	CTRE3522
ENG. MGR:			SCALE:	FILE NO. : F:\ECS\CONV\MST\CTRE3522	SHEET: 1 OF 1

4

3

2

1