

This print and associated documents and the contained information are the confidential property of ELECTRONIC CABLE SPECIALISTS. Disclosure of, and/or reproduction of, all or part thereof or manufacture of any part from information contained on this print not specifically permitted by ELECTRONIC CABLE SPECIALISTS in writing is forbidden.

**** EXPORT CONTROLLED DOCUMENT - EAR ****
 The information in this document is subject to the export controls in accordance with the export administration regulations. Diversion contrary to U.S. Law is prohibited.

REVISIONS					
ECN	ZONE	REV.	DESCRIPTION	DATE	APPROVED
12488		N/C	NEW RELEASE	12/7/00	DEK
13466		A	SEE ECN	7/24/01	C CHAPMAN
17356		B	CHANGED STIFFENER AND STRIPPING DIM'S	4/16/03	D KNOLL
49716	C,D	4	ADDED DIMENSIONS	7/1/13	CAC

INSTALLATION INSTRUCTIONS

1. BEGIN BY CUTTING THE CABLE OFF SQUARE.

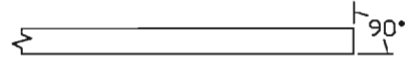

2. STRIP THE CABLE AS SHOWN, BEGINNING WITH L1 AND ENDING WITH L2. TAKE CARE NOT TO NICK THE CONDUCTORS WHILE STRIPPING THE DIELECTRIC AND JACKET. THE USE OF A STRIPPER DESIGNED FOR COAXIAL CABLE IS RECOMMENDED.

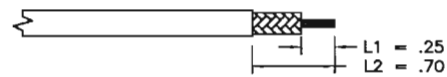

3. SLIDE THE FERRULE AND ADHESIVE SHRINK TUBING OVER THE END OF THE CABLE.

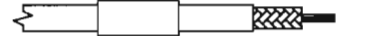

4. USING TWEEZERS, FOLD THE OUTER BRAID BACK OVER THE CABLE JACKET, LEAVING AS MUCH WEAVE AS POSSIBLE.



5. SLIT FOIL LONGITUDINALLY AND FOLD BACK OVER THE OUTER SHIELD.



6. REMOVE THE DIELECTRIC FROM THE CENTER CONDUCTOR BACK APPROXIMATELY .60 INCHES FROM THE END OF THE CONDUCTOR. BE CAREFUL NOT TO NICK THE CENTER CONDUCTOR. THERMAL STRIPPERS ARE RECOMMENDED. LEAVE APPROXIMATELY .09 INCHES OF DIELECTRIC ON THE CABLE FOR THE CUP IN THE STIFFENER.

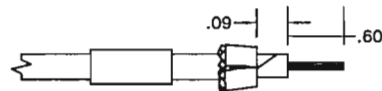

7. INSTALL DIELECTRIC STIFFENER OVER CENTER CONDUCTOR AND THE CABLE DIELECTRIC MAKING SURE THAT CABLE DIELECTRIC IS FULLY SEATED INSIDE CUPPED END OF DIELECTRIC STIFFENER.



8. ENSURE THAT THE CONTACT IS BUTTED AGAINST THE DIELECTRIC STIFFENER. TERMINATE CONTACT USING METHOD A OR B.
 a) SOLDER CONTACT ONTO CENTER CONDUCTOR. PER MIL-STD-2000. USING 63Sn/37Pb SOLDER. CLEAN FLUX RESIDUE USING APPROPRIATE CLEANER.
 b) CRIMP CONTACT ONTO CENTER CONDUCTOR USING A M22520/5-09 DIE (B HEX). IN A M22520/5-01 TOOL FRAME.



9. SLIDE THE BODY OF THE CONNECTOR OVER THE END OF THE CABLE UNTIL THE NOTCH IN THE CONTACT SEATS INTO THE RIDGE INSIDE THE CONNECTOR DIELECTRIC.

CAUTION: PUSH CABLE INTO THE CONNECTOR STRAIGHT TO AVOID KINKING THE CABLE.

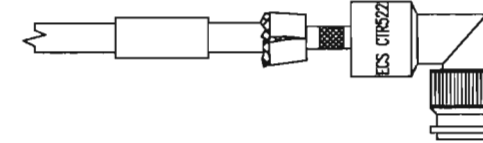

10. FOLD BOTH SHIELDS BACK OVER THE NECK OF THE CONNECTOR BODY.

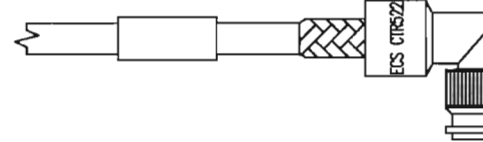

11. SLIDE THE FERRULE UP OVER THE SHIELDS AND AGAINST THE CONNECTOR BODY. TRIM AWAY ANY EXCESS BRAID. CRIMP THE FERRULE ONCE, NEXT TO THE BODY, USING A M22520/5-09 DIE (A HEX) IN A M22520/5-01 TOOL FRAME. APPLY ADHESIVE HEAT SHRINK.

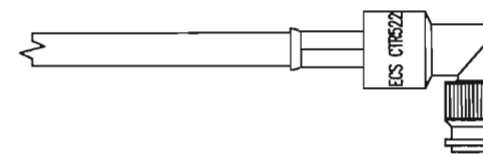

NOTES

- 1 ENSURE HEAT SHRINK IS INSTALLED PRIOR TO CRIMPING CONNECTOR.
- 2 ADHESIVE HEAT SHRINK SHOULD BE APPLIED IN ACCORDANCE WITH ECS WORK INSTRUCTION WI0007. CONTACT ECS FOR A COPY OF THIS WORK INSTRUCTION.
- 3 CONNECTOR DIMENSIONS ARE FOR REFERENCE ONLY.

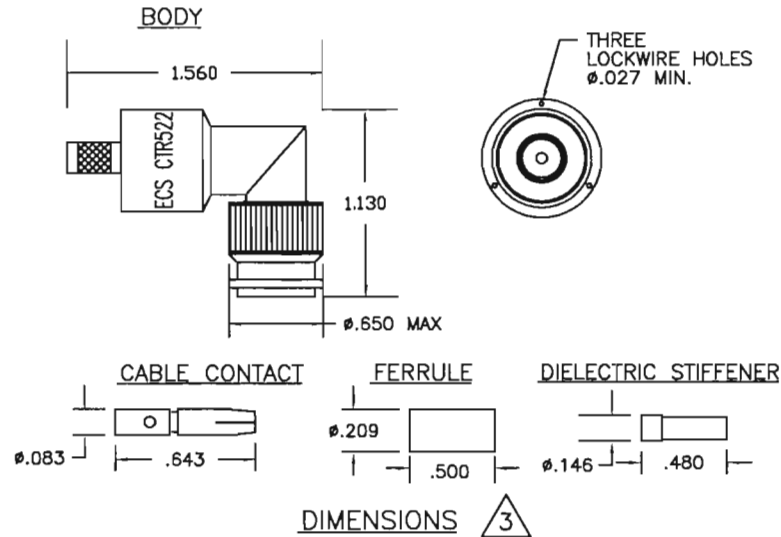

SPECIFICATIONS

ELECTRICAL

IMPEDANCE: 50 OHMS NOMINAL
 FREQUENCY RANGE: 0-11 GHz
 VSWR: 1.35:1 MAXIMUM DC TO 2GHz
 INSERTION LOSS: .1dB MAXIMUM DC TO 2GHz
 WORKING VOLTAGE: 500 VRMS @ SEA LEVEL
 DIELECTRIC WITHSTANDING: 1500 VRMS @ SEA LEVEL
 INSULATION RESISTANCE: 5000 MEGOHMS MINIMUM @ 500 VOLTS DC

MECHANICAL

CONNECTOR INTERFACE: DIMENSIONS PER MIL-STD-348A FIGURE 313-1 (TNC)
 TERMINATION STYLE: CABLE CONTACT-SOLDER OR CRIMP FERRULE-CRIMP
 CABLE RETENTION: 15 LBS

ENVIRONMENTAL

TEMPERATURE RATING: -65° TO +165° C
 VIBRATION: MIL-STD-202, METHOD 204, COND. B
 SHOCK: MIL-STD-202, METHOD 213, COND. I
 THERMAL SHOCK: MIL-STD-202, METHOD 107, COND. B
 CORROSION: MIL-STD-202, METHOD 101, COND. B
 MOISTURE RESISTANCE: MIL-STD-202, METHOD 106

MATERIALS

BODY: BRASS PER ASTM B16
 FERRULE: ANNEALED, BRASS PER ASTM B16 OR COPPER PER ASTM B124
 CABLE CONTACT: BERYLLIUM COPPER PER ASTM B196
 CENTER CONTACT: BRASS PER ASTM B16
 OUTER CONTACT: BERYLLIUM COPPER PER ASTM B196
 DIELECTRIC: TEFLON PER D1710
 GASKET: SILICONE RUBBER PER ZZ-R-765
FINISHES
 BODY, FERRULE AND OUTER CONTACT: BRIGHT NICKEL PER QQ-N-290
 CENTER CONTACT: GOLD PER MIL-G-45204

ALL LENGTHS IN INCHES		ECS ELECTRONIC CABLE SPECIALISTS FRANKLIN, WI 53132 PHONE: (414) 421-5300	
APPROVALS	DATE	TITLE: CUSTOMER SPECIFICATION	
DRAWN BY: C CHAPMAN	9/21/00	TNC RIGHT ANGLE PLUG FOR ECS CABLE 432101 AND 532101	
CHECKED BY: D KNOLL	12/7/00	SIZE: B	CAGE CODE: 66197
DESIGNED BY:		LEVEL: C	PART NO.: CTR522
PROJECT ENG:		SCALE:	EFFECTIVITY:
ENG. MGR: D KNOLL	12/7/00	SHEET: 1 OF 1	