

SSMP® Interconnect Series



INTRODUCTION

Carlisle Interconnect Technologies (CarlisleIT) designed the SSMP® connector product line to further improve package density of RF/Microwave systems. The SSMP® interface is about 30% smaller than its predecessor, the SMP connector. Now an industry standard (as outlined in the MIL-STD-348 document) for RF/Microwave applications, the SSMP® interface has enabled design engineers to increase performance and complexity of their designs while simultaneously improving upon their form factor.

The SSMP® interconnect system relies on a floating female-to-female adapter, commonly referred to as a “bullet”, to enable stacking of boards equipped with an SSMP® male PCB connector. The durable construction and ability to tolerate radial and axial misalignment allows for a blindmate interconnect solution that can withstand multiple engagement/ disengagement cycles without degradation in electrical performance.

Due to its high frequency performance along with a blindmate configuration, the SSMP® connector is a standard interface in optical networking components, specifically 40G and 100G Modulator and Driver amplifiers.

FEATURES

- » Frequency Range: DC - 65 GHz
- » 50 Ω Impedance; Blindmateable configuration
- » MIL-PRF-39012 compliant
- » Ability to withstand Radial/Axial Misalignment
- » Board-mount, Field-replaceable, Bullets, Hermetic and Cable Connector configurations
- » Custom Connectors Available

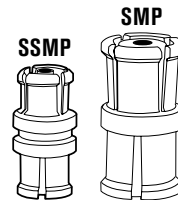

40G Optical Modulator with SSMP® Connector

SPECIFICATIONS

Parameter		Specification
Impedance		50 Ω
Frequency range		DC - 65 GHz
VSWR		1.02 + 0.12 F (GHz)
Insertion Loss		0.04 x √F (GHz)
DWV		325 Vrms
Insulation Resistance		5000 MΩ (min)
RF High Pot		190 Vrms @ 5 MHz
Force to Engage	Detent	6.5 lbs (max)
	Smooth Bore	2.5 lbs (max)
Force to Disengage	Detent	4 lbs (min)
	Smooth Bore	1.5 lbs (min)
Radial Misalignment		+/- .010 inches
Axial Misalignment		0.000/0.010 inches
Temperature range		-55° C to +165° C
Thermal Shock		MIL-STD-202, Method 107, Cond. C
Moisture Resistance		MIL-STD-202, Method 106, except step 7b
Corrosion		MIL-STD-202, Method 101, Cond. B
Vibration		MIL-STD-202, Method 204, Cond. D
Shock		MIL-STD-202, Method 213, Cond. I

CABLE CONNECTORS - FOR FLEXIBLE CABLES

SSMP Male Straight Panel Mount Connector for 0.086" Flexible Cable / P156

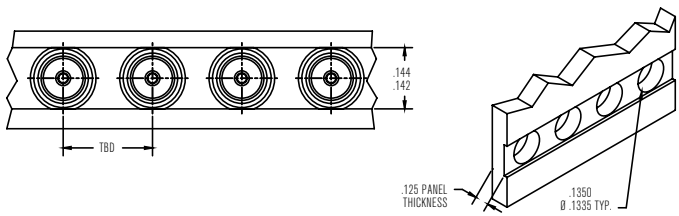
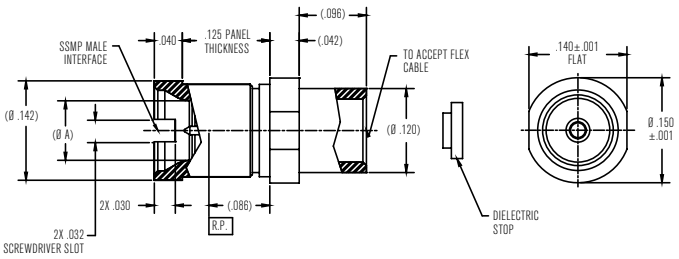
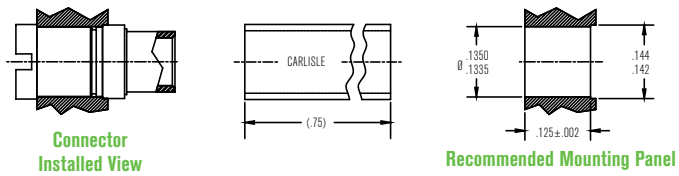

P/N	INTERFACE(S)	(Ø A)	CABLE TYPE
-1CCSF	DETENT	(.0845)	TLL40-1087, TLL18-1087, T-FLEX 405HF, Ø .095 MICROFLEX
-2CCSF	SMOOTH BORE	(.0875)	

CABLE CONNECTORS - FOR SEMI-RIGID & SEMI-FLEX® CABLES

SSMP Female Right Angle for Semi-Rigid and Semi-Flex Cable / P105

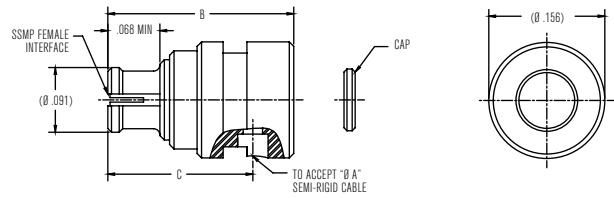

P/N	Ø A	B	C
-1CC	.047	.250	.195
-2CC	.085	.250	.195
-3CC	.047 L/L	.178	.126

SSMP Female Straight Connector for Semi-Rigid and Semi-Flex Cable / P107

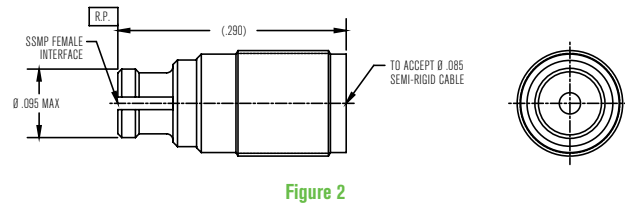
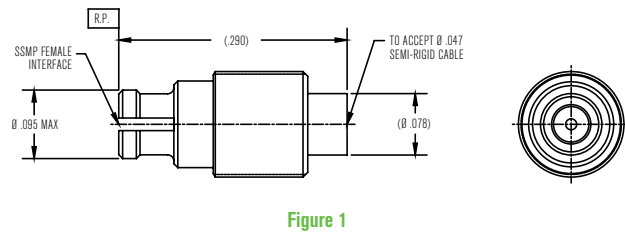

P/N	FIGURE(S)	CABLE TYPE
-1CC	1	Ø.047 CABLE
-2CC	2	Ø.085 CABLE

SSMP Female Right Angle for 0.047" Semi-Rigid and Semi-Flex Cable / P148-1CC

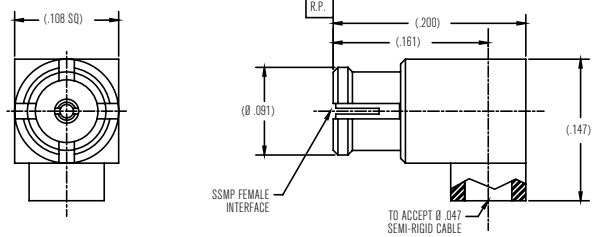
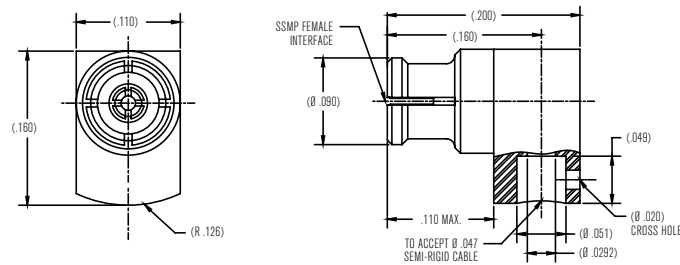

SSMP Female Snap-In Panel Mount Connector for Semi-Rigid and Semi-Flex Cables / P172-1CC

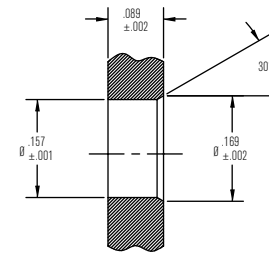
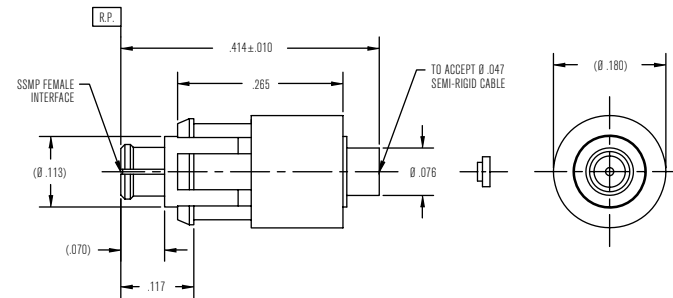

Recommended Mounting Hole

SSMP Male Snap in Panel Mount Connector for Semi-Rigid and Semi-Flex Cable / P155

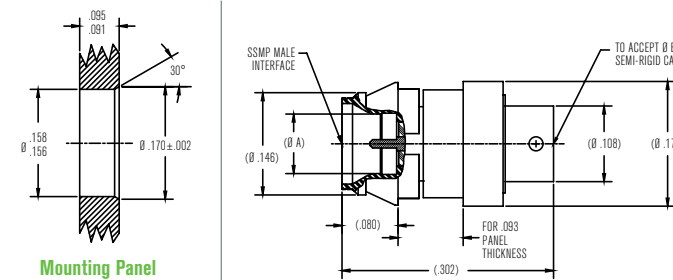

Mounting Panel Scale: None

P/N	Ø A	INTERFACE	Ø B CABLE
-1CCSF	.088	SMOOTH BORE	.086
-2CCSF	.085	DETENT	.086
-3CCSF	.088	SMOOTH BORE	.047
-4CCSF	.085	DETENT	.047

PCB CONNECTORS - SURFACE MOUNT

SSMP Male Straight Surface Mount / P311

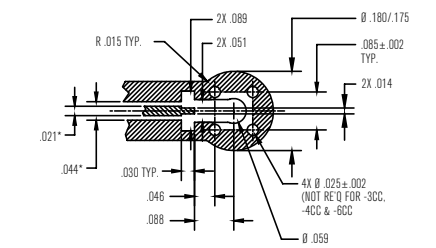
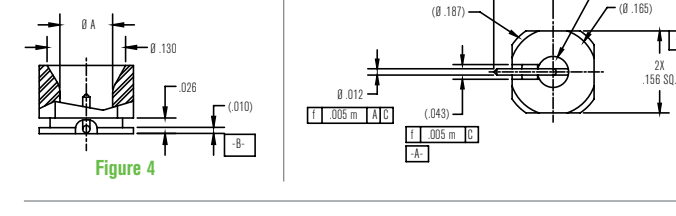
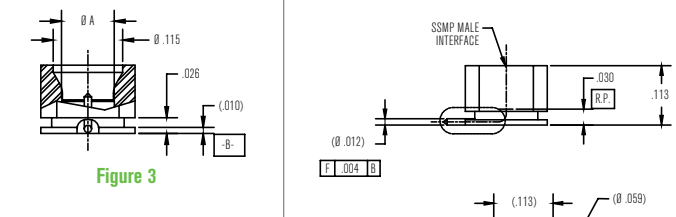
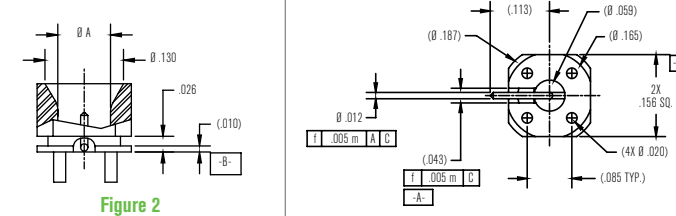
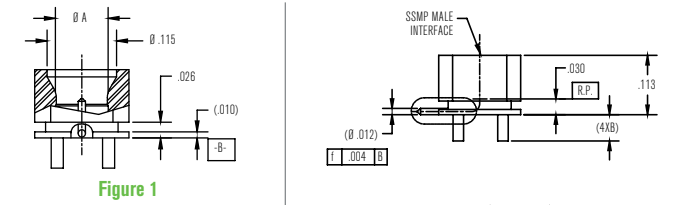

Mounting Hole Pattern

* DIMENSIONS SHOWN ARE FOR ROGERS 4350 PCB MATERIAL. THESE DIMENSIONS MAY VARY DEPENDING ON PCB MATERIAL USED.

P/N	Ø A	B	INTERFACE	FIGURE
-1CC	.085	.050	DETENT	1
-2CC	.088	.050	NON-DETENT	1
-3CC	.085	NR	DETENT	3
-4CC	.088	NR	DETENT	3
-5CC	.088	.050	CATCHERS MITT	2
-6CC	.088	NR	CATCHERS MITT	4

PCB CONNECTORS - THROUGH HOLE

SSMP Male Right Angle PCB Mount / P303

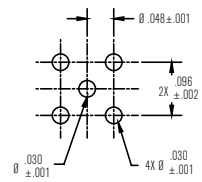
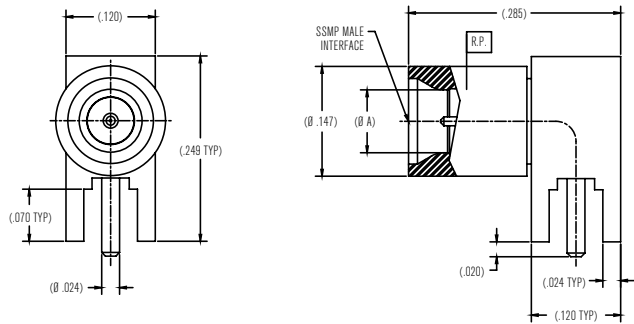

Recommended Mounting Hole Pattern

P/N	INTERFACE	(Ø A)
-1CC	DETENT	(.084)
-2CC	SMOOTH BORE	(.088)

PCB CONNECTORS - EDGE MOUNT

SSMP Male Straight Edge Mount Connector / P319

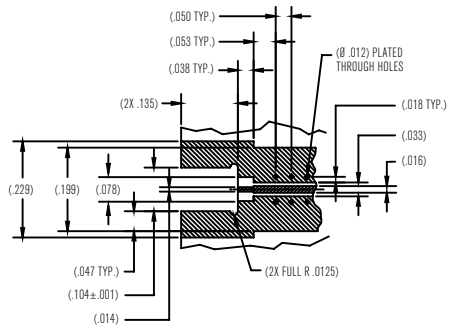
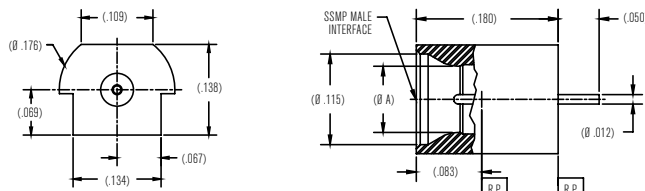

Recommended PCB Cutout Scale: 6/1

P/N	INTERFACE	(Ø A)
-1CC	DETENT	(.085)
-2CC	SMOOTH BORE	(.088)

PANEL MOUNT - THREAD-IN

SSMP Male Thread-In Panel Mount / P121

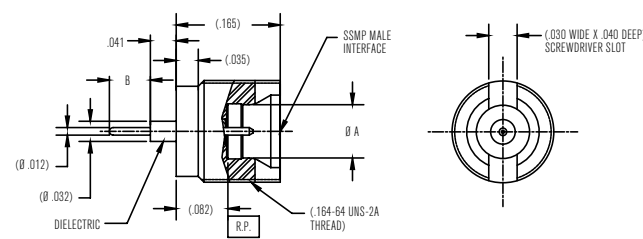

Figure 1

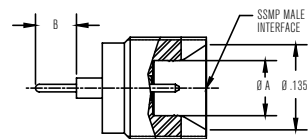
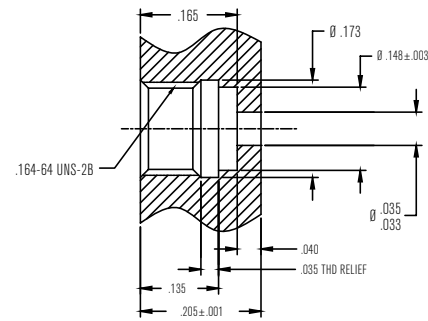

Figure 2



Recommended Mounting Hole

P/N	Ø A	B	INTERFACE	FIGURE
-1CCSF	.0840/.0850	.015	DETENT	1
-2CCSF	.0860/.0880	.015	SMOOTH BORE	1
-3CCSF	.0840/.0850	.065	DETENT	1
-4CCSF	.0860/.0880	.065	SMOOTH BORE	1
-5CCSF	.0860/.0880	.015	CATCHERS MITT	2
-6CCSF	.0860/.0880	.065	CATCHERS MITT	2

PANEL MOUNT - FLANGE MOUNT

SSMP Male 2-Hole Flange Mount / P203

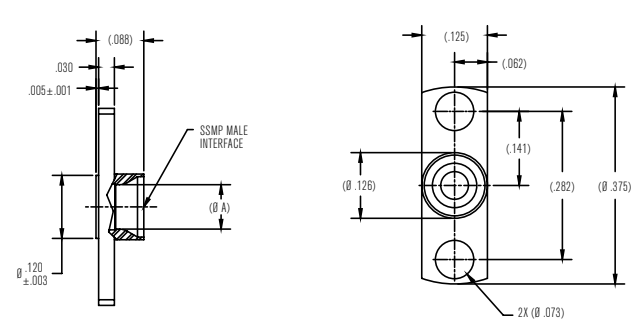

P/N	INTERFACE	(Ø A)
-1SF	FULL DETENT	.0840
-2SF	SMOOTH BORE	.0880

SHROUDS - THREAD-IN

SSMP Male Thread-In Shroud / P202

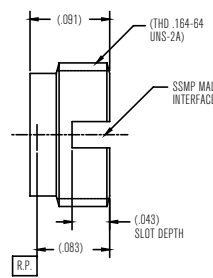

Figure 1

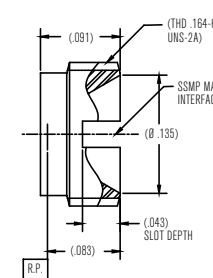
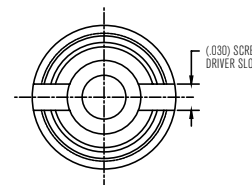

Figure 2



P/N	INTERFACE	FIGURE
-1CCSF	DETENT	1
-2CCSF	SMOOTH BORE	1
-3CCSF	CATCHERS MITT	2

SHROUDS - PRESS-IN

SSMP Male Press-In Shroud / P205

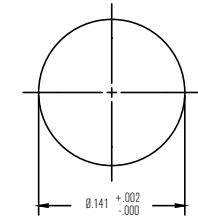
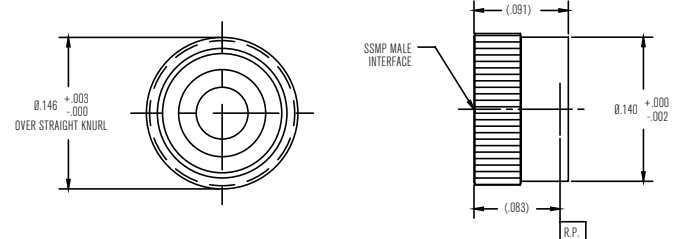

Recommended Mounting Hole

P/N	INTERFACE
-1SF	DETENT
-2SF	SMOOTH BORE

HERMETICS

SSMP Male Straight Hermetic Termination / P122

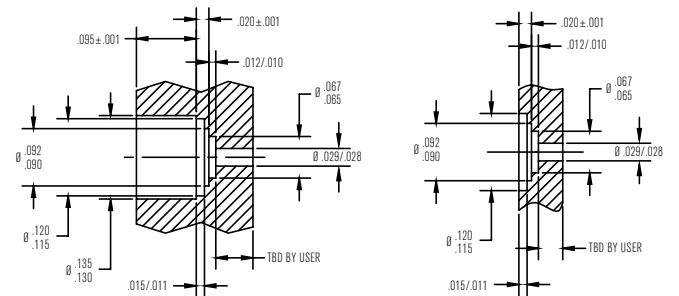
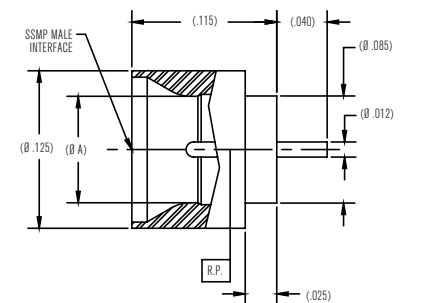

P/N	INTERFACE	(Ø A)
-3CC	DETENT	.084
-4CC	SMOOTH BORE	.088

HERMETICS (CONT.)

SSMP Male with Detent, Straight Solder-In Hermetic / P154

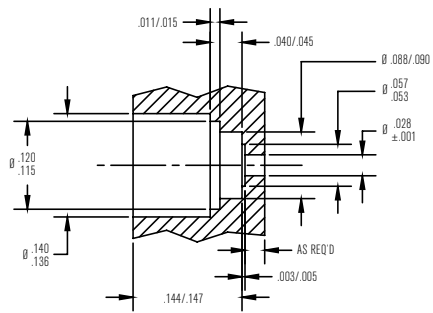
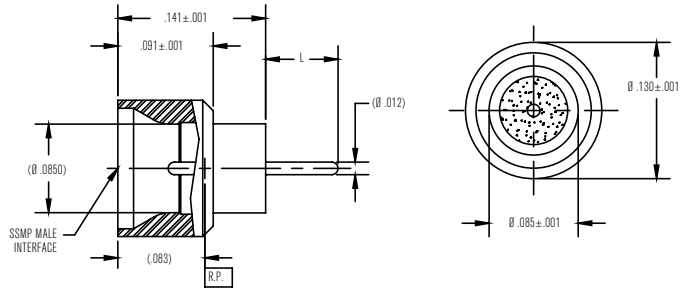

Recommended Mounting Hole Scale 10:1

P/N	L	P/N	L
-1CC	.030	-12CC	.085
-2CC	.035	-13CC	.090
-3CC	.040	-14CC	.095
-4CC	.045	-15CC	.100
-5CC	.050	-16CC	.105
-6CC	.055	-17CC	.110
-7CC	.060	-18CC	.115
-8CC	.065	-19CC	.120
-9CC	.070	-20CC	.125
-10CC	.075	-21CC	.130
-11CC	.080	-22CC	.135



SSMP Male with Detent, Straight Solder-In Hermetic / P154

LOADS

SSMP Female 50 Ω Termination / P109-1CC

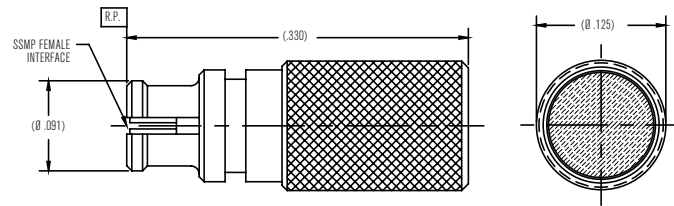

SSMP Male 50 Ω Termination / P110

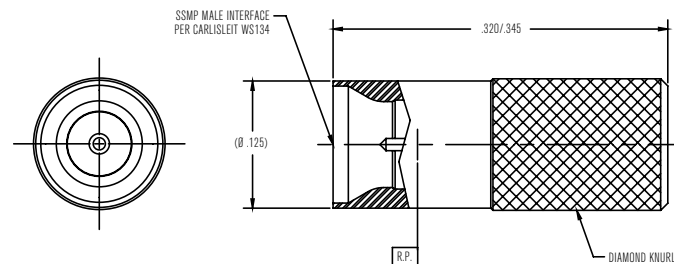

P/N	INTERFACE
-1CCSF	DETENT
-2CCSF	SMOOTH BORE

OPENS

SSMP Female Open / P171-1CC

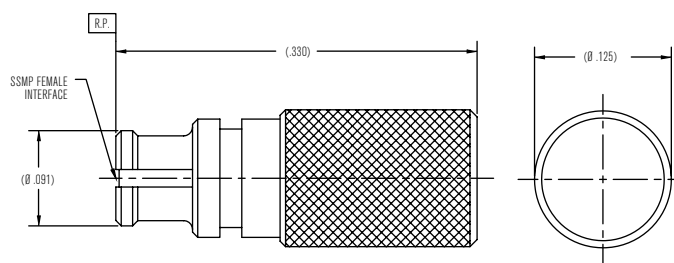

SSMP Female to SSMP Female Bullet / P101-1CC

SHORTS

SSMP Female Short / P170-1CC

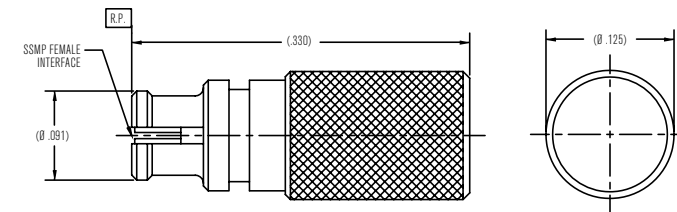

SSMP Male Short / P180

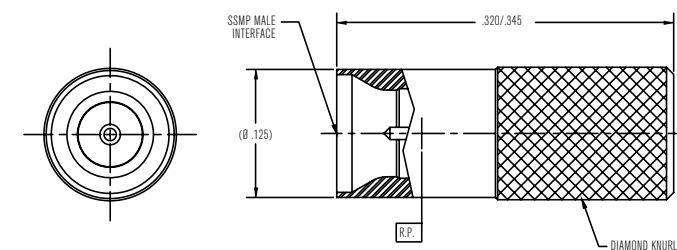

P/N	INTERFACE
-1CCSF	DETENT
-2CCSF	SMOOTH BORE

BULLETS / ADAPTERS

SSMP Female to SSMP Female Bullet / P101

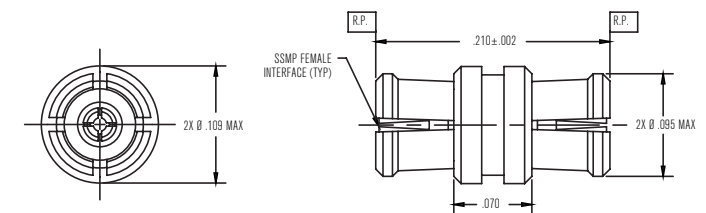

Figure 1

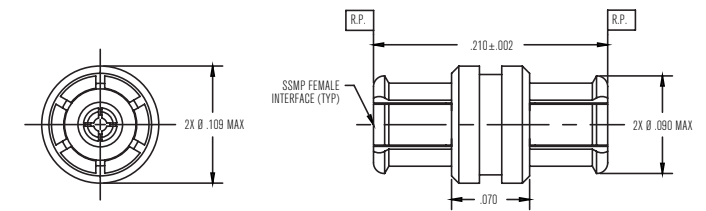
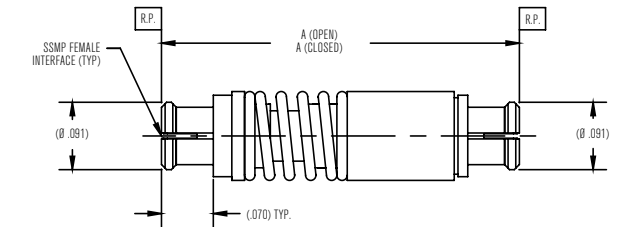

Figure 2

P/N	FIGURE	OTHER
-1CC	1	4-SLOT BODY
-2CC	2	6-SLOT BODY

SSMP Female to SSMP Female Spring Loaded Bullet / P138



P/N	A (OPEN)	A (CLOSE)
-1CCSF	(.515)	(.490)
-2CCSF	(.490)	(.465)
-3CCSF	(.465)	(.440)
-5CCSF	(.552)	(.502)
-6CCSF	(.600)	(.550)
-7CCSF	(.427)	(.387)

Ordering Information

MATERIALS & FINISH

Dielectric	Specification
Virgin PTFE Fluorocarbon	ASTM D 1710 and ASTM D 1457
Polyamide-imide	ASTM D5204 Group 2 Class 1
Glass	Corning 7070 or Equivalent
Finish	Specification
Gold (75u in. Typ)	ASTM-B488 Type 1, Class 1.25
Nickel (100u in. Typ)	SAE AMS-QQ-N-290
Passivation	ASTM A967

Metal	Specification
BeCu (Beryllium Copper)	ASTM B 196 and/or ASTM B 197
Brass	ASTM B 36, B121, B16, B16M
Stainless Steel	ASTM A484/ A582 or A555/581
Iron-Nickel-Cobalt	ASTM F-15

ORDERING INFORMATION

Configuration	Part Number*	Description	Options	
Cable Connectors	For Flexible Cables	P156	SSMP (male) straight panel mount connector for 0.086" flexible cable	See table for options
	For Semi-Rigid & Semi-Flex® Cables	P107	SSMP (female) straight connector for semi-rigid and Semi-Flex cables	See respective tables for options (see figure)
		P105	SSMP (female) right angle for semi-rigid/Semi-Flex cables	
		P148	SSMP (female) right angle for 0.047" semi-rigid/Semi-Flex cables	
		P172	SSMP (female) snap-in panel mount connector for semi-rigid/Semi-Flex cables	
		P155	SSMP (male) snap-in panel mount connector for semi-rigid/Semi-Flex cables	
PCB Connectors	Through Hole	P303	SSMP (male) right angle PCB mount	Different detents available (see figure)
	Surface Mount	P311	SSMP (male) straight surface mount	
	Edge Mount	P319	SSMP (male) straight edge mount connector	
Panel Mount	Flange Mount	P203	SSMP (male) 2-hole flange mount	See table for detents
	Thread-In	P121	SSMP (male) thread-in panel mount	
Shrouds	Thread-In	P202	SSMP (male) thread-in shroud	See table for detents
	Press-In	P205	SSMP (male) press-in shroud	
Hermetics		P122	SSMP (male) straight hermetic termination	Different detents and pin styles available
		P154	SSMP (male) with detent, straight solder-in hermetic	
Loads		P109-1CC ⁺	SSMP (female) 50 Ω termination	See table for detents
		P110	SSMP (male) 50 Ω termination	
Shorts		P170-1CC ⁺	SSMP (female) short	See table for detents
		P180	SSMP (male) short	
Opens		P171-1CC	SSMP (female) open	See table for detents
Bullets/Adapters		P101	SSMP (female) to SSMP (female) bullet	4-slot & 6-slot CC designs available (see table)
		P138	SSMP (female) to SSMP (female) spring loaded bullet	
		P123-1CCSF ⁺	SSMP (female) to SMK/2.92mm (male) straight adapter	
		P125-1CCSF ⁺	SSMP (female) to SMK/2.92mm (female) straight adapter	
		P127	SSMP (female) to SMA (female) straight adapter	
		P130	SSMP (male) to SMA (male) straight adapter	
		P128	SSMP (male) to SMA (female) straight adapter	

* Part numbers have a suffix based on the option selected. Please refer to outline drawings for more information

+ These part numbers don't require an additional suffix