

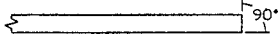

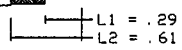

This print and associated documents and the contained information are the confidential property of ELECTRONIC CABLE SPECIALISTS. Disclosure of, and/or reproduction of, all or part thereof or manufacture of any part from information contained on this print not specifically permitted by ELECTRONIC CABLE SPECIALISTS in writing is forbidden.

**INSTALLATION INSTRUCTIONS**

- BEGIN BY CUTTING THE CABLE OFF SQUARE. 
- STRIP THE CABLE AS SHOWN, BEGINNING WITH L1 AND ENDING WITH L2. TAKE CARE NOT TO NICK THE CONDUCTORS WHILE STRIPPING THE DIELECTRIC AND JACKET. THE USE OF A STRIPPER DESIGNED FOR COAXIAL CABLE IS RECOMMENDED. 

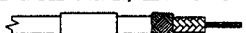
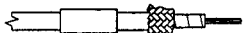
- SLIDE THE FERRULE AND ADHESIVE SHRINK TUBING OVER THE END OF THE CABLE. 
- USING TWEEZERS, FOLD THE OUTER BRAID BACK OVER THE CABLE JACKET, LEAVING AS MUCH WEAVE AS POSSIBLE. 

- USING TWEEZERS, FOLD THE INNER BRAID BACK OVER THE OTHER SHIELD, LEAVING AS MUCH WEAVE AS POSSIBLE. 

- REMOVE THE DIELECTRIC FROM THE CENTER CONDUCTOR BACK TO THE BEGINNING OF THE FOLDED BACK SHIELD, APPROXIMATELY .60 INCHES FROM THE END OF THE CENTER CONDUCTOR. BE CAREFUL NOT TO NICK THE CENTER CONDUCTOR. THERMAL STRIPPERS ARE RECOMMENDED. 

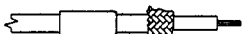
- INSTALL DIELECTRIC STIFFENER OVER CENTER CONDUCTOR, ENSURING THAT IT IS BUTTED AGAINST THE CABLE DIELECTRIC. 

- SOLDER THE CONTACT ONTO THE CENTER CONDUCTOR, PER MIL-STD-2000, USING 63Sn/37Pb SOLDER OR CRIMP WITH M22520/5-11 DIE (B HEX). ENSURE THE CONTACT IS BUTTED AGAINST THE DIELECTRIC STIFFENER. CLEAN ALL FLUX RESIDUES USING AN APPROPRIATE FLUX CLEANER. 

REVISIONS					
ECN	ZONE	REV.	DESCRIPTION	DATE	APPROVED
2975		N/C	NEW RELEASE	8/18/95	JBH
4443		A	SEE ECN# 4443	8/13/96	JBH
6189		B	SEE ECN# 6189	9/10/98	MCT
12885		C	SEE ECN	12/7/00	CAC
13466		D	SEE ECN	7/27/01	C Chapman

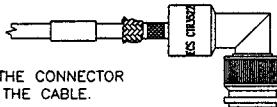
- SLIDE THE BODY OF THE CONNECTOR OVER THE END OF THE CABLE UNTIL THE NOTCH IN THE CONTACT SEATS WITH THE DIELECTRIC RIDGE INSIDE THE CONNECTOR. 

**CAUTION:** PUSH CABLE INTO THE CONNECTOR STRAIGHT, TO AVOID KINKING THE CABLE.

- FOLD BOTH BRAIDS OVER THE NECK OF THE CONNECTOR BODY. 

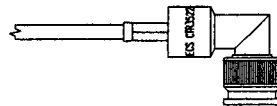
- SLIDE THE FERRULE OVER THE SHIELDS AND AGAINST THE CONNECTOR BODY. TRIM AWAY ANY EXCESS BRAID. CRIMP THE FERRULE ONCE, NEXT TO THE BODY, USING A M22520/5-11 DIE (A HEX) IN A M22520/5-01 TOOL FRAME. APPLY ADHESIVE HEAT SHRINK. 

**NOTES**

- ALL DIMENSIONS ARE IN INCHES.
- ENSURE HEAT SHRINK IS INSTALLED PRIOR TO CRIMPING CONNECTOR.
- ADHESIVE HEAT SHRINK SHOULD BE APPLIED IN ACCORDANCE WITH ECS WORK INSTRUCTION W10007. CONTACT ECS FOR A COPY OF THIS WORK INSTRUCTION.
- CONNECTOR DIMENSIONS ARE FOR REFERENCE ONLY.
- DELETED.
- DELETED.

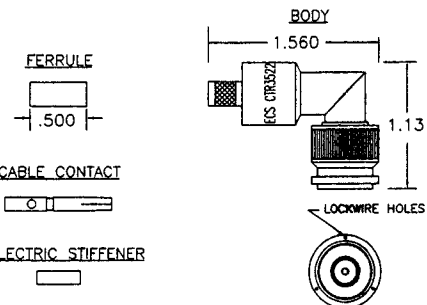

**DIMENSIONS** 

**SPECIFICATIONS**

**ELECTRICAL**  
 IMPEDANCE: 50 OHMS NOMINAL  
 FREQUENCY RANGE: 0-11 GHz  
 VSWR: 1.2:1 MAXIMUM DC TO 2GHz  
 INSERTION LOSS: .1dB MAXIMUM DC TO 2GHz  
 WORKING VOLTAGE: 500 VRMS @ SEA LEVEL  
 DIELECTRIC WITHSTANDING: 1500 VRMS @ SEA LEVEL  
 INSULATION RESISTANCE: 5000 MEGOHMS MINIMUM @ 500 VOLTS DC

**MECHANICAL**  
 CONNECTOR INTERFACE: DIMENSIONS PER MIL-STD-348A FIGURE 313-1  
 TERMINATION STYLE: CABLE CONTACT-SOLDER OR CRIMP FERRULE-CRIMP  
 CABLE RETENTION: 20 LBS

**ENVIRONMENTAL**  
 TEMPERATURE RATING: -65° TO +165° C  
 VIBRATION: MIL-STD-202, METHOD 204, COND. B  
 SHOCK: MIL-STD-202, METHOD 213, COND. I  
 THERMAL SHOCK: MIL-STD-202, METHOD 107, COND. B  
 CORROSION: MIL-STD-202, METHOD 101, COND. B  
 MOISTURE RESISTANCE: MIL-STD-202, METHOD 106

**MATERIALS**  
 BODY: BRASS PER QQ-B-626  
 FERRULE: ANNEALED BRASS PER QQ-B-626  
 CABLE CONTACT: BERYLLIUM COPPER PER QQ-C-530  
 CENTER CONTACT: BRASS PER QQ-B-626  
 OUTER CONTACT: BERYLLIUM COPPER PER QQ-C-530  
 DIELECTRIC: TEFLON PER L-P-403  
 GASKET: SILICONE RUBBER PER ZZ-R-765

**FINISHES**  
 BODY, FERRULE AND OUTER CONTACT: BRIGHT NICKEL PER QQ-N-290  
 CENTER CONTACT: GOLD PER MIL-G-45204

ALL LENGTHS IN INCHES		ECS ELECTRONIC CABLE SPECIALISTS FRANKLIN, WI 53132 PHONE: (414) 421-5300	
APPROVALS	DATE	TITLE: CUSTOMER SPECIFICATION	
DRAWN BY: KW HOFFMAN	8/3/95	RIGHT ANGLE TNC PLUG FOR ECS CABLE 352001	
CHECKED BY: M TAUBENHEIM	8/18/95	SIZE: B	CAGE CODE: 66197
DESIGNED BY:		LEVEL:	PART NO. CTR3522
PROJECT ENG:		SCALE:	FILE NO. F:\E\SPEC\COMM\MST\CTR3522
ENG. MGR: JB HACKETT	8/18/95		SHEET: 1 OF 1