

This print and associated documents and the contained information are the confidential property of ELECTRONIC CABLE SPECIALISTS. Disclosure of, and/or reproduction of, all or part thereof or manufacture of any part from information contained on this print not specifically permitted by ELECTRONIC CABLE SPECIALISTS in writing is forbidden.

INSTALLATION INSTRUCTIONS

REVISIONS					
ECN	ZONE	REV.	DESCRIPTION	DATE	APPROVED
21604	-	N/C	NEW RELEASE	12/20/04	EJK

1. BEGIN BY CUTTING THE CABLE OFF SQUARE.



2. WHEN USING AUTOMATIC STRIPPING EQUIPMENT, STRIP CABLE AS SHOWN STARTING WITH L1 AND ENDING WITH L3. TAKE CARE NOT TO NICK THE CONDUCTORS WHILE STRIPPING THE DIELECTRIC AND JACKET. IF AUTOMATIC STRIPPING EQUIPMENT IS NOT AVAILABLE, STRIP ONLY L1 AND L3 AND TRIM EXCESS BRAID AT STEP 10.

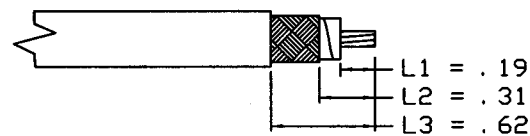

3. SLIDE THE FERRULE AND ADHESIVE SHRINK TUBING OVER THE END OF THE CABLE.

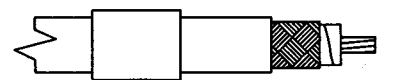

4. SOLDER THE CONTACT ONTO THE CENTER CONDUCTOR, PER MIL-STD-2000, USING 63Sn/37Pb SOLDER OR CRIMP WITH A Y1757 DIE. ENSURE THE CONTACT IS BUTTED AGAINST THE CABLE DIELECTRIC. CLEAN ALL FLUX RESIDUES USING AN APPROPRIATE FLUX CLEANER.

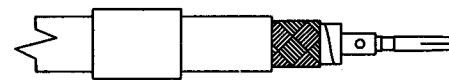

5. USING TWEEZERS, FOLD THE OUTER BRAID BACK OVER THE CABLE JACKET, LEAVING AS MUCH WEAVE AS POSSIBLE.



6. SLICE THE ALUMINUM/POLYESTER FOIL LENGTHWISE ABOUT EVERY 1/8". GENTLY ROTATE PIN TO SEPARATE THE FLAT FOIL BRAID AND ALUMINUM/POLYESTER FOIL FROM THE DIELECTRIC. USING TWEEZERS, FOLD BACK ALUMINUM/POLYESTER FOIL OVER THE OUTER BRAID.



7. USING TWEEZERS, FOLD THE INNER BRAID BACK OVER THE OTHER SHIELDS, LEAVING AS MUCH WEAVE AS POSSIBLE. NOTE: DO NOT UNRAVEL DIELECTRIC WHEN PULLING BACK INNER SHIELD.



8. SLIDE THE BODY OF THE CONNECTOR OVER THE END OF THE CABLE UNTIL THE NOTCH IN THE CONTACT SEATS WITH THE DIELECTRIC RIDGE INSIDE THE CONNECTOR BODY.

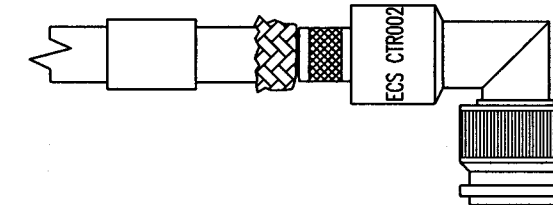

9. FOLD ALL THREE BRAIDS UP OVER THE NECK OF THE CONNECTOR BODY.

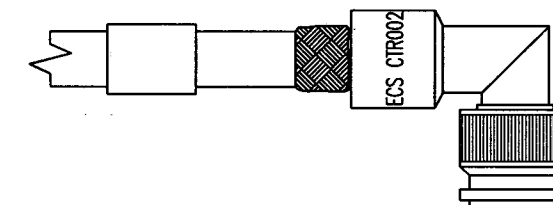

10. SLIDE THE FERRULE UP OVER THE SHIELDS AND AGAINST THE CONNECTOR BODY. TRIM AWAY ANY EXCESS BRAID. CRIMP THE FERRULE ONCE, NEXT TO THE BODY, USING THE M22520/5-31 DIE IN A M22520/5-01 TOOL FRAME. APPLY ADHESIVE HEAT SHRINK.

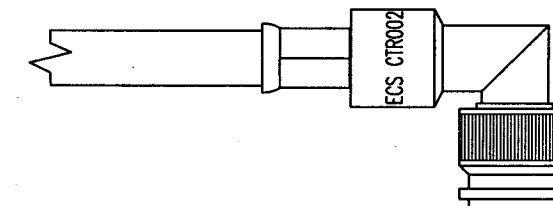

NOTES

- 1 ENSURE HEAT SHRINK IS INSTALLED PRIOR TO CRIMPING CONNECTOR.
- 2 ADHESIVE HEAT SHRINK SHOULD BE APPLIED IN ACCORDANCE WITH ECS WORK INSTRUCTION W1007. CONTACT ECS FOR A COPY OF THIS WORK INSTRUCTION.
- 3 CONNECTOR DIMENSIONS ARE FOR REFERENCE ONLY.

D

D

C

C

B

B

A

A

FERRULE

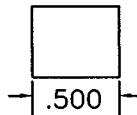

CABLE CONTACT

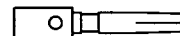

DIMENSIONS

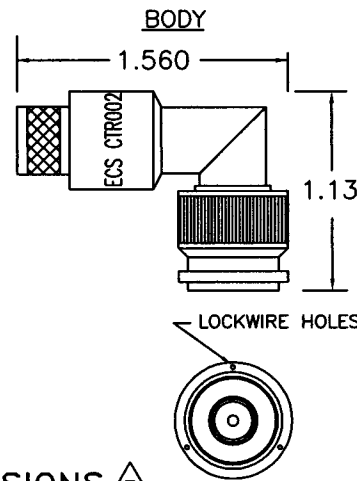

SPECIFICATIONS

ELECTRICAL

IMPEDANCE: 50 OHMS NOMINAL
 FREQUENCY RANGE: 0-11 GHz
 VSWR: 1.2:1 MAXIMUM DC TO 2GHz
 INSERTION LOSS: .1dB MAXIMUM DC TO 2GHz
 WORKING VOLTAGE: 500 VRMS @ SEA LEVEL
 DIELECTRIC WITHSTANDING: 1500 VRMS @ SEA LEVEL
 INSULATION RESISTANCE: 5000 MEGOHMS MINIMUM @ 500 VOLTS DC

MECHANICAL

CONNECTOR INTERFACE: DIMENSIONS PER MIL-STD-348A FIGURE 313-1 (TNC)
 TERMINATION STYLE: CABLE CONTACT-SOLDER OR CRIMP FERRULE-CRIMP
 CABLE RETENTION: 60 LBS

ENVIRONMENTAL

TEMPERATURE RATING: -65° TO +165° C
 VIBRATION: MIL-STD-202, METHOD 204, COND. B
 SHOCK: MIL-STD-202, METHOD 213, COND. I
 THERMAL SHOCK: MIL-STD-202, METHOD 107, COND. B
 CORROSION: MIL-STD-202, METHOD 101, COND. B
 MOISTURE RESISTANCE: MIL-STD-202, METHOD 106

MATERIALS

BODY: BRASS PER QQ-B-626
 FERRULE: ANNEALED BRASS PER QQ-B-626
 CABLE CONTACT: BERYLLIUM COPPER PER QQ-C-530
 CENTER CONTACT: BRASS PER QQ-B-626
 OUTER CONTACT: BERYLLIUM COPPER PER QQ-C-530
 DIELECTRIC: TEFLON PER L-P-403
 GASKET: SILICONE RUBBER PER ZZ-R-765

FINISHES

BODY, FERRULE AND OUTER CONTACT: BRIGHT NICKEL PER QQ-N-290
 CENTER CONTACT: GOLD PER MIL-G-45204

ALL LENGTHS IN INCHES		ELECTRONIC CABLE SPECIALISTS FRANKLIN, WI 53132 PHONE: (414) 421-5300	
APPROVALS	DATE	TITLE: CUSTOMER SPECIFICATION	
DRAWN BY: C. CHAPMAN	12/14/04	TNC RIGHT ANGLE PLUG FOR ECS CABLE 310701	
CHECKED BY: [Signature]	12/20/04	SIZE: B	CAGE CODE: 66197
DESIGNED BY:		LEVEL:	PART NO. CTR002
PROJECT ENG:		SCALE:	FILE NO: F:\E\SPEC\CONN\INST\CTR002
ENG. MGR: [Signature]	12/20/04	SHEET: 1 OF 1	