

4

3

 DWG NO. **BTS922-1** SH 1 REV. D

1

This print and associated documents and the contained information are the confidential property of ELECTRONIC CABLE SPECIALISTS. Disclosure of, and/or reproduction of, all or part thereof or manufacture of any part from information contained on this print not specifically permitted by ELECTRONIC CABLE SPECIALISTS in writing is forbidden.

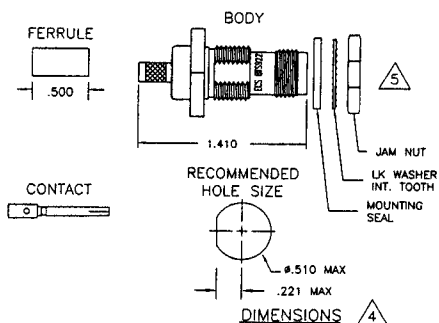

#### SPECIFICATIONS

##### ELECTRICAL

IMPEDANCE: 50 OHMS NOMINAL  
 FREQUENCY RANGE: 0-11 GHz  
 VSWR: 1.2:1 MAXIMUM DC TO 2GHz  
 INSERTION LOSS: .1dB MAXIMUM DC TO 2GHz  
 WORKING VOLTAGE: 500 VRMS @ SEA LEVEL  
 DIELECTRIC WITHSTANDING: 1500 VRMS @ SEA LEVEL  
 INSULATION RESISTANCE: 5000 MEGOHMS MINIMUM @ 500 VOLTS DC

##### MECHANICAL

CONNECTOR INTERFACE DIMENSION PER MIL-STD-348A FIGURE 313-2  
 TERMINATION STYLE: INNER CONTACT-SOLDER OR CRIMP  
 OUTER CONTACT-FERRULE CRIMP  
 CABLE RETENTION: 40 LBS

##### ENVIRONMENTAL

TEMPERATURE RATING: -65° TO +165° C  
 VIBRATION: MIL-STD-202, METHOD 204, COND. B  
 SHOCK: MIL-STD-202, METHOD 213, COND. I  
 THERMAL SHOCK: MIL-STD-202, METHOD 107, COND. B  
 CORROSION: MIL-STD-202, METHOD 101, COND. B  
 MOISTURE RESISTANCE: MIL-STD-202, METHOD 106

##### MATERIALS

BODY: BRASS PER QQ-B-626  
 FERRULE: ANNEALED BRASS PER QQ-B-626  
 CENTER CONTACT: BERYLLIUM COPPER PER QQ-C-530  
 DIELECTRIC: TEFLON PER L-P-403  
 GASKET: SILICONE RUBBER PER ZZ-R-765

##### FINISHES

BODY, FERRULE: BRIGHT NICKEL PER QQ-N-290  
 CENTER CONTACT: GOLD PER MIL-G-45204

#### INSTALLATION INSTRUCTIONS

1. BEGIN BY CUTTING THE CABLE OFF SQUARE.

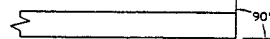

2. WHEN USING AUTOMATIC STRIPPING EQUIPMENT, STRIP CABLE AS SHOWN STARTING WITH L1 AND ENDING WITH L3. TAKE CARE NOT TO NICK THE CONDUCTORS WHILE STRIPPING THE DIELECTRIC AND JACKET. IF AUTOMATIC STRIPPING EQUIPMENT IS NOT AVAILABLE, STRIP ONLY L1 AND L3 AND TRIM EXCESS BRAID AT STEP 10.

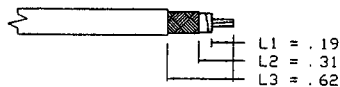

3. SLIDE THE FERRULE AND ADHESIVE SHRINK TUBING OVER THE END OF THE CABLE.

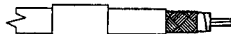

4. SOLDER THE CONTACT ONTO THE CENTER CONDUCTOR, PER MIL-STD-2000, USING 63Sn/37Pb SOLDER OR CRIMP WITH M22520/5-59 DIE (B HEX). ENSURE THE CONTACT IS BUTTED AGAINST THE CABLE DIELECTRIC. CLEAN ALL FLUX RESIDUES USING AN APPROPRIATE FLUX CLEANER.



5. USING TWEEZERS, FOLD THE OUTER BRAID BACK OVER THE CABLE JACKET, LEAVING AS MUCH WEAVE AS POSSIBLE.



6. SLICE THE ALUMINUM/POLYESTER FOIL LENGTHWISE ABOUT EVERY 1/8". GENTLY ROTATE PIN TO SEPARATE THE FLAT FOIL BRAID AND ALUMINUM/POLYESTER FOIL FROM THE DIELECTRIC. USING TWEEZERS, FOLD BACK ALUMINUM/POLYESTER FOIL OVER THE OUTER BRAID.



7. USING TWEEZERS, FOLD THE INNER BRAID BACK OVER THE OTHER SHIELDS, LEAVING AS MUCH WEAVE AS POSSIBLE. NOTE: DO NOT UNRAVEL DIELECTRIC WHEN PULLING BACK INNER SHIELD.



REVISIONS					
ECN	ZONE	REV.	DESCRIPTION	DATE	APPROVED
2356		N/C	NEW RELEASE.	1/20/95	JBH
3335		A	CHANGED TITLE BLOCK.	5/21/95	JBH
4458		B	SEE ECN# 4458	8/12/96	JBH
6189		C	SEE ECN# 6189	9/16/98	MCT
13273		D	SEE ECN# 13279	7/2/01	ic cl pma

8. SLIDE THE BODY OF THE CONNECTOR OVER THE END OF THE CABLE UNTIL THE NOTCH IN THE CONTACT SEATS WITH THE DIELECTRIC RIDGE INSIDE THE CONNECTOR BODY.

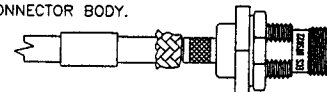

9. FOLD ALL THREE BRAIDS UP OVER THE NECK OF THE CONNECTOR BODY.

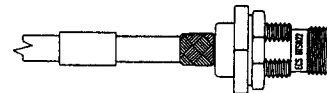

10. SLIDE THE FERRULE UP OVER THE SHIELDS AND AGAINST THE CONNECTOR BODY. TRIM AWAY ANY EXCESS BRAID. CRIMP THE FERRULE ONCE, NEXT TO THE BODY, USING THE M22520/5-59 DIE (A HEX) IN A M22520/5-01 TOOL FRAME. APPLY ADHESIVE HEAT SHRINK.

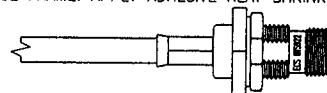

#### NOTES

- ALL DIMENSIONS ARE IN INCHES.
- ENSURE HEAT SHRINK IS INSTALLED PRIOR TO CRIMPING CONNECTOR.
- ADHESIVE HEAT SHRINK SHOULD BE APPLIED IN ACCORDANCE WITH ECS WORK INSTRUCTION W10007. CONTACT ECS FOR A COPY OF THIS WORK INSTRUCTION.
- CONNECTOR DIMENSIONS ARE FOR REFERENCE ONLY.
- INSTALL MOUNTING SEAL, LOCK WASHER AND JAMNUT IN ORDER SHOWN.
- DELETED.
- DELETED.
- PICTORIALS SHOW CONNECTOR INSTALLATION ON ECS 311501, AND 311601 CABLE. WHEN INSTALLING THIS CONNECTOR ON 421601 THERE ARE ONLY 2 SHIELDS WHICH SHOULD BE FOLDED BACK AS SHOWN IN STEP 6 AND STEP 7 WOULD BE OMITTED.

APPROVALS		DATE	ELECTRONIC CABLE SPECIALISTS FRANKLIN, WI 53132 PHONE: (414) 421-5300		
DRAWN BY: JB HACKETT		1/13/95	TITLE: <b>CUSTOMER SPECIFICATION</b>		
CHECKED BY: T MEYERS		1/20/95	TNC BULKHEAD JACK FOR ECS CABLE 311601, 311501, 421601		
DESIGNED BY:			SIZE B	CAGE CODE 66197	LEVEL PART NO. BTS922
PROJECT ENG: H STÖIBER		1/20/95	SCALE:		
ENG. MGR: JB HACKETT		1/20/95	FILE NO F:\ECS\CONV\MST\BTS922	SHEET: 1 OF 1	

4

3

2

1