

Options & Accessories

Contact facility for full listing of options.

Hold Downs

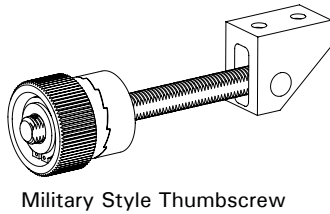
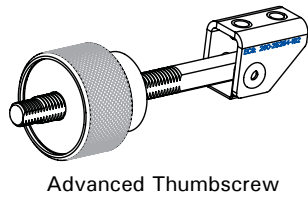
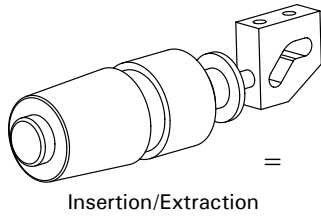

Metering Plugs and Reducing Grommets

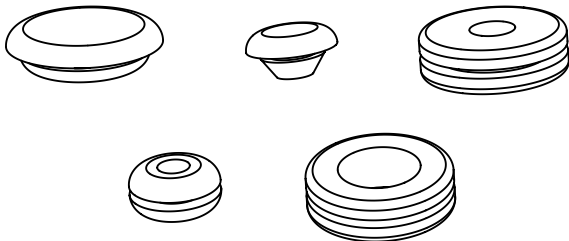

Shock and Vibration Isolators

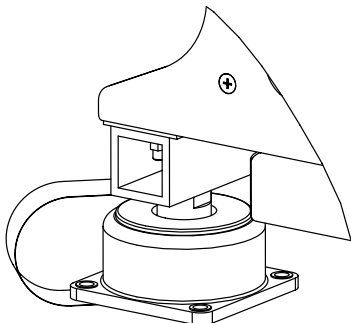

Positive Pressure Air Filters*

*Negative Pressure Air Filters available

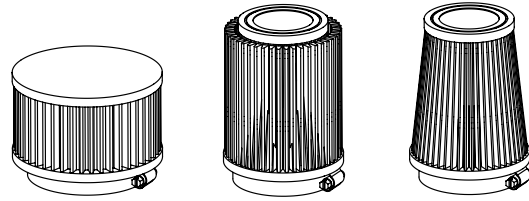

Cooling Fans and Integrated Plenums

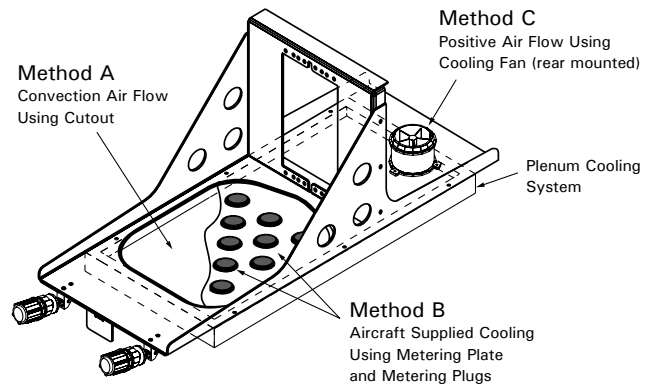

Fan Failure Monitoring, Grounding Features and Terminal Blocks

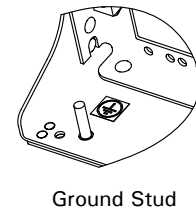
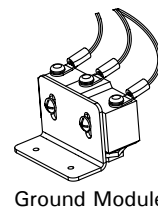
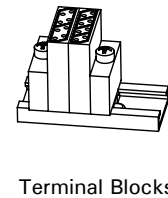
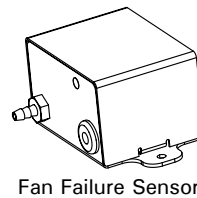
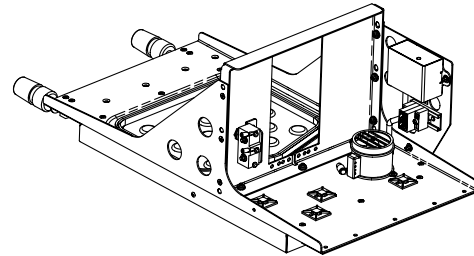

ARINC 600 Trays



ARINC 600 8 MCU Tray with Side Mounted Fan and Plenum Chamber

INTRODUCTION

All ARINC 600 Trays are designed and fabricated in our state-of-the-art manufacturing facility using top quality aircraft grade materials to meet or exceed ARINC 600 specifications, as well as all civil and military aircraft application criteria. Our special designs stand up to the most rigorous environmental hazards for in-flight and on-the-ground operations. Each tray is fully warranted, ensuring that your avionics systems equipment will not only fit securely, but operate safely. Off-the-shelf designs or custom solutions are available to best fit your requirements as well as the option of positive pressure air cooling systems through the use of an optional plenum chamber and fan.

APPLICATIONS

- » ARINC 600 Standards
- » CFR Title 14 Part 25, 23 and 21
- » RTCA/DO-160
- » Mil-Std-810

FEATURES

- » Durable, rugged construction
- » Light-weight aluminum alloy
- » 24 hour AOG support
- » Fan-cooled trays conform to ARINC Level 1 maximum cooling specifications (level 2 cooling is available if required). Cooling fans can be ordered with AC or DC power supply.
- » Available with ARINC 600 air filtration solutions
- » Clear Chem Film per Mil-DTL-5541, Type II, Class 3
- » Materials meet flammability, optical smoke density and toxic gas generation requirements
- » RoHS compliant in standard configurations

SERVICES

- » Structural Analysis
- » Shock & Vibration testing
- » Crash Safety testing
- » Finite Element Analysis
- » Flammability testing
- » Environmental testing
- » Air flow and cooling analysis and testing

ARINC 600 Trays

MOUNTING PATTERNS

The following cut away diagrams illustrate standard Front and Rear Mounting Hole placement for ARINC 600 Trays. No. 10 mounting holes are standard on all trays. No. 8 mounting holes are available as an option.

Note: Dimensions are in inches, bracketed [numbers] represent millimeters.

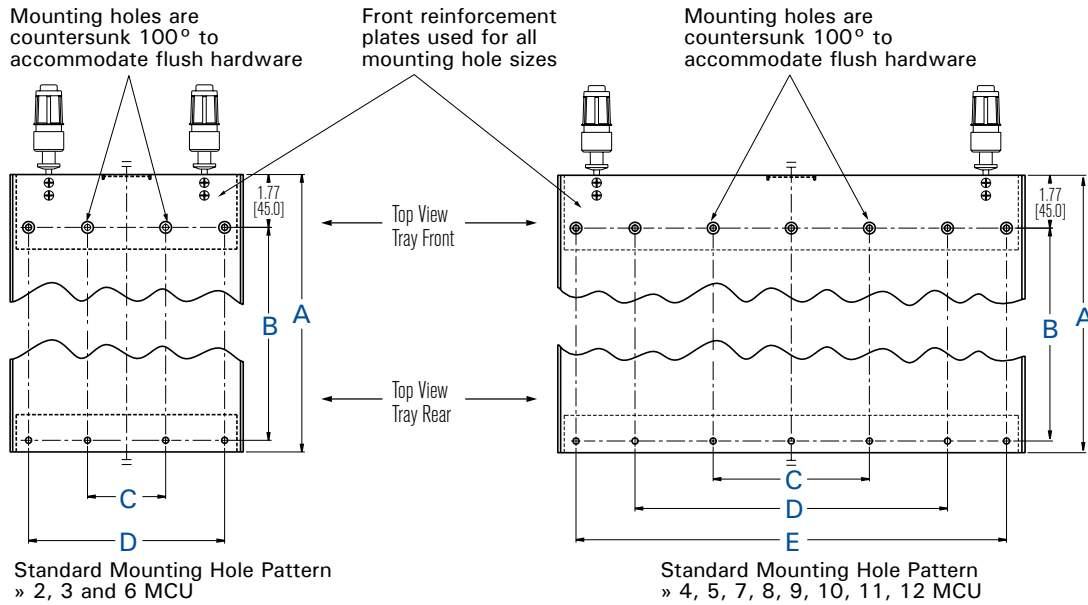

MOUNTING DIMENSIONS: REFERENCE CHART

MCU Size	A	B	C	D	E
2	14.92 [379.0]	12.76 [324.1]	1.312 [33.3]	-	-
2	20.06 [509.5]	18.00 [457.2]	1.312 [33.3]	-	-
3	14.92 [379.0]	12.76 [324.1]	2.624 [66.6]	-	-
3	20.06 [509.5]	18.00 [457.2]	2.624 [66.6]	-	-
4	14.92 [379.0]	12.76 [324.1]	3.936 [100.0]	-	-
4	20.06 [509.5]	18.00 [457.2]	3.936 [100.0]	-	-
5	14.92 [379.0]	12.76 [324.1]	5.248 [133.3]	-	-
5	20.06 [509.5]	18.00 [457.2]	5.248 [133.3]	-	-
6	14.92 [379.0]	12.76 [324.1]	2.624 [66.6]	6.560 [166.6]	-
6	20.06 [509.5]	18.00 [457.2]	2.624 [66.6]	6.560 [166.6]	-
7	14.92 [379.0]	12.76 [324.1]	5.248 [133.3]	7.872 [199.9]	-
7	20.06 [509.5]	18.00 [457.2]	5.248 [133.3]	7.872 [199.9]	-
8	14.92 [379.0]	12.76 [324.1]	5.248 [133.3]	9.184 [233.3]	-
8	20.06 [509.5]	18.00 [457.2]	5.248 [133.3]	9.184 [233.3]	-
9	14.92 [379.0]	12.76 [324.1]	5.248 [133.3]	10.496 [266.6]	-
9	20.06 [509.5]	18.00 [457.2]	5.248 [133.3]	10.496 [266.6]	-
10	14.92 [379.0]	12.76 [324.1]	5.248 [133.3]	11.808 [299.9]	-
10	20.06 [509.5]	18.00 [457.2]	5.248 [133.3]	11.808 [299.9]	-
11	14.92 [379.0]	12.76 [324.1]	5.248 [133.3]	13.120 [333.2]	-
11	20.06 [509.5]	18.00 [457.2]	5.248 [133.3]	13.120 [333.2]	-
12	14.92 [379.0]	12.76 [324.1]	5.248 [133.3]	10.496 [266.6]	14.432 [366.6]
12	20.06 [509.5]	18.00 [457.2]	5.248 [133.3]	10.496 [266.6]	14.432 [366.6]

DIMENSIONAL DATA

Short/Short and Short/Long Trays

Note: Dimensions are in inches, bracketed [numbers] represent millimeters.

Typical Side View

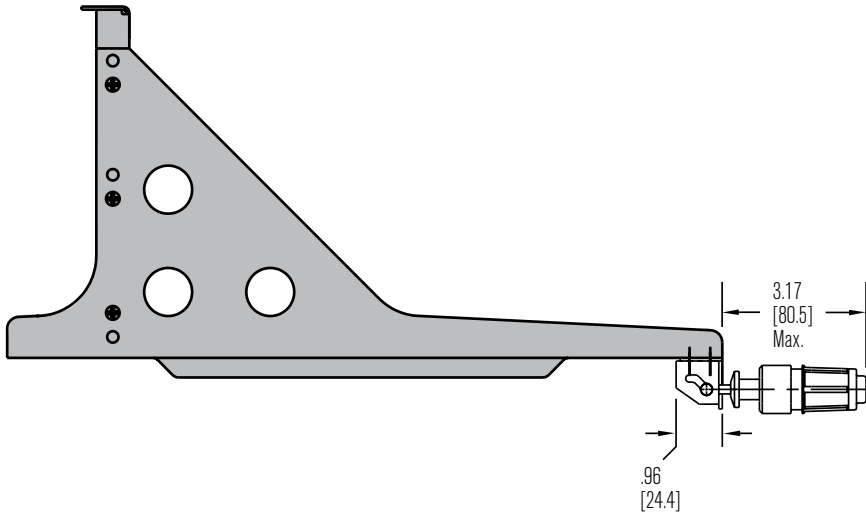

Typical Top View

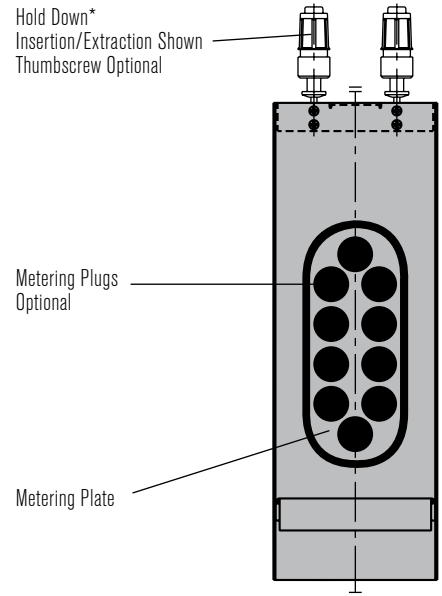

MCU Size	A (Outside Dimensions)
1MCU	1.22 [31.0]
2MCU	2.51 [63.8]
3MCU	3.81 [96.8]
4MCU	5.13 [130.3]
5MCU	6.43 [163.3]
6MCU	7.73 [196.3]
7MCU	9.03 [229.4]
8MCU	10.33 [262.4]
9MCU	11.63 [295.4]
10MCU	12.93 [328.4]
11MCU	14.23 [361.4]
12MCU	15.53 [394.5]

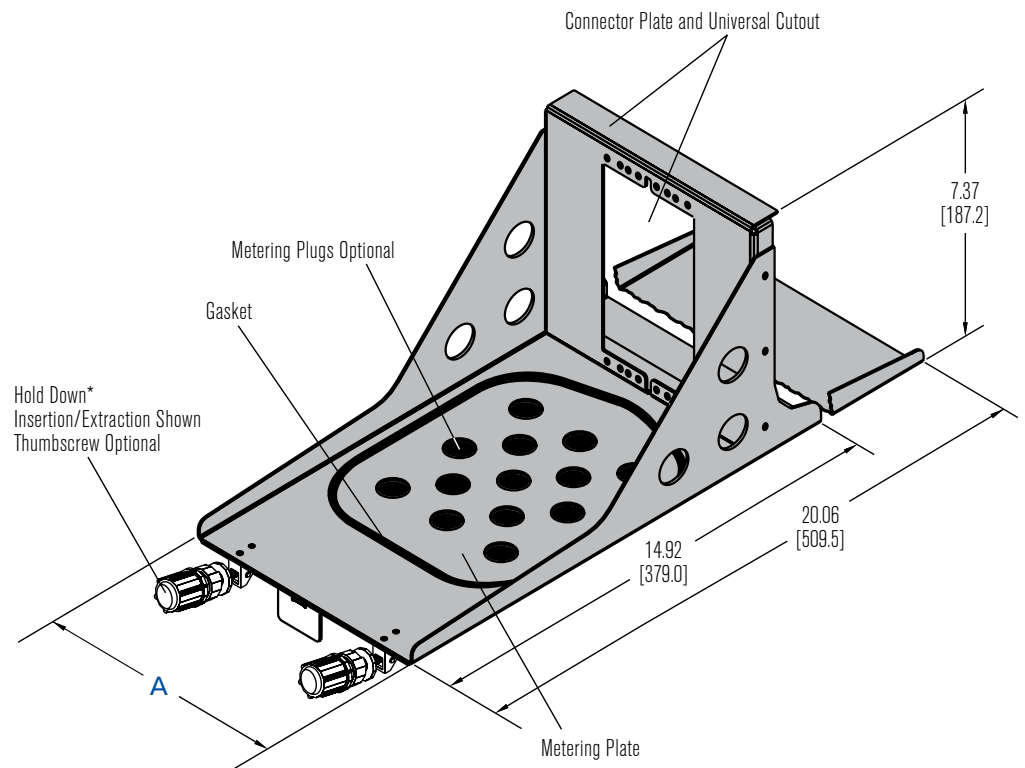

*Thumbscrew Hold Down options include: Insertion/Extraction, Advanced Thumbscrew and Military Style Thumbscrew.

All dimensions shown represent CarlisleIT's Standard tray dimensions and frequently requested options. CarlisleIT can customize any of these features to suit your specific needs.